

Universitatea Națională de Educație Fizică și Sport din București  Admitere	ADMISSION TO 1 <sup>ST</sup> CYCLE BACHELOR'S PROGRAMMES STUDY PROGRAMME IN FOREIGN LANGUAGE	EDIȚIA: 1 REVIZIA: 3
	COD M – AD – 07 - 01 - 03	APROBARE Hotărâre de Senat 40/28.02.2023

**NATIONAL UNIVERSITY OF PHYSICAL EDUCATION AND  
SPORT BUCHAREST**

**FACULTY OF PHYSICAL EDUCATION AND SPORT**



**ADMISSION TO 1<sup>ST</sup> CYCLE BACHELOR'S PROGRAMMES**

**STUDY PROGRAMME IN FOREIGN  
LANGUAGE**

**PHYSICAL EDUCATION AND SPORT  
– French Programme –**

**COD M – AD – 07 – 01-03**

<b>Elaborat</b>	<b>Verificat</b>	<b>Aprobat</b>	<b>Aprobat</b>
Facultăți Comisia de admitere	CEAC	Senatul Universității	Rector
Prof.univ.dr. Alina Moanță Conf.univ.dr. Hantău Cezar	Președinte Prof.univ. dr. Monica Stănescu	Președinte Prof.univ. Virgil Tudor	Prof. univ. dr. Florin Pelin

<b>Universitatea Națională de Educație Fizică și Sport din București</b>  <b>Admitere</b>	<b>ADMISSION TO 1<sup>ST</sup> CYCLE BACHELOR'S PROGRAMMES STUDY PROGRAMME IN FOREIGN LANGUAGE</b>	<b>EDIȚIA: 1 REVIZIA: 3</b>
	<b>COD M – AD – 07 - 01 - 03</b>	<b>APROBARE Hotărâre de Senat 40/28.02.2023</b>

## CONTENTS

<i>OVERVIEW</i> .....	3
<i>ADMISSION OF CANDIDATES</i> .....	4
<i>ADMISSION TESTS</i> .....	4
<i>ADMISSION CALENDAR</i> .....	5
<i>DOCUMENTS REQUIRED FOR ADMISSION</i> .....	5
<i>ENTRANCE EXAMINATION</i> .....	12
<i>CALCULATION OF OVERALL ADMISSION AVERAGE</i> .....	14
<i>COMPLAINTS</i> .....	15
<i>FINAL RESULTS OF ENTRANCE EXAMINATION</i> .....	15
<i>REGISTRATION OF ADMITTED CANDIDATES</i> .....	16
<i>APPENDIX</i> .....	17

Universitatea Națională de Educație Fizică și Sport din București  Admitere	ADMISSION TO 1 <sup>ST</sup> CYCLE BACHELOR'S PROGRAMMES STUDY PROGRAMME IN FOREIGN LANGUAGE	EDIȚIA: 1 REVIZIA: 3
	COD M – AD – 07 - 01 - 03	APROBARE Hotărâre de Senat 40/28.02.2023

## OVERVIEW

The NATIONAL UNIVERSITY OF PHYSICAL EDUCATION AND SPORT IN BUCHAREST, 140 Constantin Noica Street, sector 6, standard phone number: +40/021 316 41 07, Rector's Secretariat: +40/021 316 41 08, fax: +40/021 312 04 00, website address: [www.unefs.ro](http://www.unefs.ro), e-mail: [secretariat@unefs.ro](mailto:secretariat@unefs.ro). organizes entrance examination for the academic year 2023-2024, for the Faculty of Physical Education and Sport, study programme **PHYSICAL EDUCATION AND SPORT – taught in French**.

At the FACULTY OF PHYSICAL EDUCATION AND SPORT, according to *National Education Law no. 1/2011 with subsequent amendments, the Ministry of Education (ME) and ME Order no. 6102/2016 for the approval of the Framework-Methodology for organizing admission to bachelor's, master's PhD programmes*, the university studies are carried out in two cycles within the programmes accredited/authorised by ME, according to Governmental Decision regarding the approval of the Nomenclature of the fields and specializations/ university study programmes and the structure of higher education institutions for the academic year 2023-2024:

- 1<sup>st</sup> cycle – Bachelor's programmes: 3 years, 6 semesters, full-time education and part-time education in the field of Sport and Physical Education Science, *Bachelor's Degree in Physical Education and Sport*
- 2<sup>nd</sup> cycle – Master's programmes: 2 years, 4 semesters, full-time education, *Master's Degree in Sport and Physical Education Science*

For the academic year 2023 - 2024, the Physical education and sport programme – taught in French, admission to bachelor's programmes is organized for *tuition fee places, 50 in number*.

According to *National Education Law no. 1/2011 with subsequent amendments, Governmental Decision no. 615/2017 and Governmental Decision no. 326/2019*, graduates with a Bachelor's Degree in another field may follow a second degree at UNEFS, within the limit of the number of places established by the UNEFS Senate, no more than two-degree programmes simultaneously, regardless of the institutions providing them.

After examination, graduates will receive the Bachelor's Degree in PHYSICAL EDUCATION AND SPORT and the Diploma Supplement (Appendix to Bachelor's Degree).

Universitatea Națională de Educație Fizică și Sport din București  Admitere	ADMISSION TO 1 <sup>ST</sup> CYCLE BACHELOR'S PROGRAMMES STUDY PROGRAMME IN FOREIGN LANGUAGE	EDIȚIA: 1 REVIZIA: 3
	COD M – AD – 07 - 01 - 03	APROBARE Hotărâre de Senat 40/28.02.2023

## ADMISSION OF CANDIDATES

Admission to bachelor's programmes is open for citizens from Member States of European Union, European Economic Area and Swiss Confederation, on the same terms provided by law for Romanian citizens, including tuition fees. The study documents of these citizens and Romanian citizens with studies abroad must be equated by ME through the National Centre for Recognition and Equivalence of Diplomas.

Candidates from non-EU countries can also apply, according to current legislation.

## ADMISSION TESTS

**1. Language Proficiency Test** – ELIMINATORY, where candidates receive a pass or fail grade. Language proficiency can be proven through certificates issued by institutions recognized by the Ministry of Education and Research. Applicants who hold certificates/international certificates of proficiency may benefit from their recognition and therefore from equivalence of the language proficiency exam. Candidates from countries whose official language is French are exempt from submitting this test.

*NOTE: For candidates from Member States of European Union, European Economic area and Swiss Confederation, as well as those from non-EU countries, who apply for authorized/accredited study programmes where the teaching process is conducted in foreign languages, UNEFS organizes a language proficiency test in the teaching language of the programme. Candidates from countries where the official language is the language in which courses are taught and those who hold an internationally recognized language certificate are exempt from this test.*

**2.** Regarding the admission to BACHELOR'S PROGRAMME, candidates will have to go through the following stages:

### 1) PRELIMINARY CONDITION

The medical visit is a preliminary condition for all study programs, being materialized with FIT / UNFIT FOR PHYSICAL SPORTS EFFORT.

The medical visit can be performed at sports medicine centers in the candidate's locality/county of origin. The medical certificate must be issued by a specialist doctor with a specialization in sports medicine and must contain the mention "FIT FOR PHYSICAL SPORTS EFFORT".

Universitatea Națională de Educație Fizică și Sport din București  Admitere	ADMISSION TO 1 <sup>ST</sup> CYCLE BACHELOR'S PROGRAMMES STUDY PROGRAMME IN FOREIGN LANGUAGE	EDIȚIA: 1 REVIZIA: 3
	COD M – AD – 07 - 01 - 03	APROBARE Hotărâre de Senat 40/28.02.2023

**The medical certificate is valid for 6 months from the date of the medical examination.**

The medical examination is considered an exam, graded as accepted / rejected. In the absence of the medical certificate and the aforementioned medical visa, the candidate is rejected.

- 2) **PRACTICAL TEST.** The candidate completes a general motor skills circuit, described in the Appendix A.

Participation in the practical test is conditioned by obtaining the medical visa FIT FOR PHYSICAL SPORTS EFFORT.

#### **WEIGHTED AVERAGE CALCULATED BETWEEN:**

- The grade obtained in the specific motor skills practical test, which is eliminatory - weighting 50%. Additional details regarding the content of this test are presented in Appendix A.
- The grade obtained in the language of study within the baccalaureate exam - weighting 50%.

The specific motor skills test will be graded on a scale of 1 to 10. Candidates who obtain a minimum grade of 5 (five) will not be eliminated from the competition.

### **ADMISSION CALENDAR**

*The registration of candidates takes place from September 4 to 11, 2023. The Language Proficiency Test (where appropriate) will take place on September 12, 2023.*

The admission calendar for Romanian citizens, citizens from Member States of European Union, European Economic Area and Swiss Confederation will be posted on the UNEFS website (<http://admitere.unefs.ro/>).

### **DOCUMENTS REQUIRED FOR ADMISSION**

#### **A. FOR CITIZENS FROM MEMBER STATES OF EUROPEAN UNION, EUROPEAN ECONOMIC AREA AND SWISS CONFEDERATION**

Bachelor's programmes are open for citizens of Romania, graduates holding a **HIGH-SCHOOL (BACCALAUREATE) DIPLOMA (or an equivalent certificate)** and graduates holding a **BACHELOR'S DEGREE** in another field.

Universitatea Națională de Educație Fizică și Sport din București  Admitere	ADMISSION TO 1 <sup>ST</sup> CYCLE BACHELOR'S PROGRAMMES STUDY PROGRAMME IN FOREIGN LANGUAGE	EDIȚIA: 1 REVIZIA: 3
	COD M – AD – 07 - 01 - 03	APROBARE Hotărâre de Senat 40/28.02.2023

A. For the online registration, candidates will upload the following documents:

- **Application form** (a standard registration form issued by the Registration Board) - where candidates will complete, under signature, all requested data.
- **Declaration** of consent for the processing of personal data (Appendix C)
- **Birth certificate** (marriage certificate or document certifying name change, if applicable) – *certified copy*
- **Passport** copy / Identity card and a photocopy there of (for Romanian citizens)
- **High-School (Baccalaureate) Diploma or an equivalent certificate**

For the graduates of 2023, the *original* certificate attesting successful high-school graduation is valid.

By way of exception, for Romanian applicants who have passed their high-school graduation exams in the sessions of the current school year, on the basis of their written agreement, UNEFS can interconnect with the Integrated Information System of Education in Romania (SIIIR) to take over their personal data and results achieved in high-school graduation exams, in which case the certificate issued by the educational institution is not required.

If a candidate gets enrolled in several faculties/ study programmes, they can provide certified copies (true copies\*) of these documents.

The documents mentioned above, provided *as certified copies*, will be accompanied by a *certificate* issued by the Faculty/study programme where the file has been submitted with the original documents.

- **For Roma candidates**, the file will include, in addition to the above, the following documents:
  1. written recommendation from the president of a legally established Roma organization, which proves that the candidate concerned is part of this ethnicity; membership in that organization is not taken into account;
  2. certified copy (or true copy\*) of the Court order attesting the legal establishment of that organization;
  3. self-declaration that the candidate concerned belongs to Roma ethnicity.
- **Receipt for payment of the registration fee, 50 EURO in lei at the BNR exchange rate of the day, issued by the UNEFS pay office or in the account:**  
NATIONAL UNIVERSITY OF PHYSICAL EDUCATION AND SPORT

Universitatea Națională de Educație Fizică și Sport din București  Admitere	ADMISSION TO 1 <sup>ST</sup> CYCLE BACHELOR'S PROGRAMMES STUDY PROGRAMME IN FOREIGN LANGUAGE	EDIȚIA: 1 REVIZIA: 3
	COD M – AD – 07 - 01 - 03	APROBARE Hotărâre de Senat 40/28.02.2023

CUI 4267192  
ACCOUNT (LEI) RO42RNCB0077050253860001  
ACCOUNT (EURO) RO74RNCB0077050253860007  
ROMANIAN COMMERCIAL BANK, SECTOR 6, BUCHAREST  
PAYMENT DETAILS – ADMISSION SEPTEMBER 2023

The following categories are exempt from paying the registration fee:

- Children of the (active, retired or deceased) teaching staff, who provide a **certificate** (with round stamp) issued by the institution in question;
- Children of the teaching and non-teaching staff from UNEFS who provide a **certificate** (with round stamp) issued by UNEFS;
- Candidates orphaned of both parents, who provide a **certified copy** of the death certificates of their parents;
- Candidates from orphanages and foster care centres, who provide a **certificate** (with round stamp) issued by the establishment in question;
- Candidates - Heroes of the 1989 Revolution who provide a **certified copy** proving their involvement in those events;
- Candidates with injured or deceased parents - Heroes of the 1989 Revolution who provide a **certified copy** of the medical certificate or death certificate of the parent in question.

- **Medical certificate**

The medical visit can be performed at sports medicine centers in the candidate's locality/county of origin. The medical certificate must be issued by a specialist doctor with a specialization in sports medicine and must contain the mention "FIT FOR PHYSICAL SPORTS EFFORT".

The medical certificate is valid for 6 months from the date of the medical examination.

The medical examination is considered an exam, graded as accepted / rejected.

In the absence of the medical certificate and the aforementioned medical visa, the candidate is rejected.

- **Graduation Diploma (or original certificate for the graduates of 2023) and a certified copy of the Diploma Supplement, for those who want to compete for admission to a second faculty.**

**NOTE: \*True copy - to certify compliance with the original document, candidates will provide the documents as originals and photocopies.**

**B. On registration, applicants will submit an envelope folder containing the following documents:**

Universitatea Națională de Educație Fizică și Sport din București  Admitere	ADMISSION TO 1 <sup>ST</sup> CYCLE BACHELOR'S PROGRAMMES STUDY PROGRAMME IN FOREIGN LANGUAGE	EDIȚIA: 1 REVIZIA: 3
	COD M – AD – 07 - 01 - 03	APROBARE Hotărâre de Senat 40/28.02.2023

- **Application form** (a standard registration form issued by the Registration Board) - where candidates will complete, under signature, all requested data.
- **Declaration of consent** for the processing of personal data (Appendix C)
- **Birth certificate** (marriage certificate or document certifying name change, if applicable) – certified copy.
- **Passport copy / Identity card** and a photocopy there of (for Romanian citizens)

- **High-School (Baccalaureate) Diploma or an equivalent certificate**

For the graduates of 2023, the original certificate attesting successful high-school graduation is valid.

By way of exception, for Romanian applicants who have passed their high-school graduation exams in the sessions of the current school year, on the basis of their written agreement, UNEFS can interconnect with the Integrated Information System of Education in Romania (SIIR) to take over their personal data and results achieved in high-school graduation exams, in which case the certificate issued by the educational institution is not required.

If a candidate gets enrolled in several faculties/study programmes, they can provide certified copies (true copies\*) of these documents.

The documents mentioned above, provided as certified copies, will be accompanied by a certificate issued by the Faculty/study programme where the file has been submitted with the original documents.

- **For Roma candidates**, the file will include, in addition to the above, the following documents:

1. written recommendation from the president of a legally established Roma organization, which proves that the candidate concerned belongs to this ethnicity; membership in that organization is not taken into account;

2. certified copy (or true copy\*) of the Court order attesting the legal establishment of that organization;

3. self-declaration that the candidate concerned belongs to Roma ethnicity.

- **Receipt for payment** of the registration fee, 50 EURO in lei at the BNR exchange rate of the day, issued by the UNEFS pay office or in the account:

NATIONAL UNIVERSITY OF PHYSICAL EDUCATION AND SPORT  
CUI 4267192

ACCOUNT (LEI) RO42RNCB0077050253860001

ACCOUNT (EURO) RO74RNCB0077050253860007



Universitatea Națională de Educație Fizică și Sport din București  Admitere	ADMISSION TO 1 <sup>ST</sup> CYCLE BACHELOR'S PROGRAMMES STUDY PROGRAMME IN FOREIGN LANGUAGE	EDIȚIA: 1 REVIZIA: 3
	COD M – AD – 07 - 01 - 03	APROBARE Hotărâre de Senat 40/28.02.2023

ROMANIAN COMMERCIAL BANK, SECTOR 6, BUCHAREST  
PAYMENT DETAILS – ADMISSION SEPTEMBER 2023

The following categories are exempt from paying the registration fee:

- Children of the (active, retired or deceased) teaching staff who provide a certificate (with round stamp) issued by the institution in question;
- Children of the teaching and non-teaching staff from UNEFS who provide a certificate (with round stamp) issued by UNEFS;
- Candidates orphaned of both parents who provide certified copies of the death certificates of their parents;
- Candidates from orphanages and foster care centres who provide a certificate (with round stamp) issued by the establishment in question;
- Candidates - Heroes of the 1989 Revolution who provide a certified copy proving their involvement in those events;
- Candidates with injured or deceased parents - Heroes of the 1989 Revolution who provide a certified copy of the medical certificate or death certificate of the parent in question.

- **6 (six) photos** (ID-type) (on reverse side, the candidate will write his/her surname and name).

- **Medical certificate**

The medical visit is a preliminary condition for all study programs, being materialized with FIT / UNFIT FOR PHYSICAL SPORTS EFFORT.

The medical visit can be performed at sports medicine centers in the candidate's locality/county of origin. The medical certificate must be issued by a specialist doctor with a specialization in sports medicine and must contain the mention "FIT FOR PHYSICAL SPORTS EFFORT".

The medical certificate is valid for 6 months from the date of the medical examination.

The medical examination is considered an exam, graded as accepted / rejected.

In the absence of the medical certificate and the aforementioned medical visa, the candidate is rejected.

- **Graduation Diploma** (or original certificate for the graduates of 2023) and a certified copy of the Diploma Supplement, for those who want to compete for admission to a second faculty.

NOTE: \*True copy - to certify compliance with the original document, candidates will provide the documents as originals and photocopies.

<b>Universitatea Națională de Educație Fizică și Sport din București</b>  <b>Admitere</b>	<b>ADMISSION TO 1<sup>ST</sup> CYCLE BACHELOR'S PROGRAMMES STUDY PROGRAMME IN FOREIGN LANGUAGE</b>	<b>EDIȚIA: 1 REVIZIA: 3</b>
	<b>COD M – AD – 07 - 01 - 03</b>	<b>APROBARE Hotărâre de Senat 40/28.02.2023</b>

Universitatea Națională de Educație Fizică și Sport din București  Admitere	ADMISSION TO 1 <sup>ST</sup> CYCLE BACHELOR'S PROGRAMMES STUDY PROGRAMME IN FOREIGN LANGUAGE	EDIȚIA: 1 REVIZIA: 3
	COD M – AD – 07 - 01 - 03	APROBARE Hotărâre de Senat 40/28.02.2023

## ***B. FOR NON-EU COUNTRIES***

Non-EU citizens can access higher education institutions in Romania if they:

- a) hold documents proving citizenship of the country;
- b) have the necessary background, proven by study documents issued by recognized education institutions from the country of origin;
- c) have applied according to the calendar of each education institution and have complied with the deadline set by the MEC methodology;
- d) opt for an accredited education institution and an accredited/recognized specialization/study programme;
- e) have the UNEFS permission to study at the institution;
- f) provide proof of proficiency for the language of the study programme.

For accredited study programmes where the teaching process is conducted in foreign languages, UNEFS organizes a proficiency test for the language of the study programme. Candidates from countries where the official language is the language in which courses are taught and those who hold an internationally recognized language certificate are exempt from this test.

The **registration file** will contain the following documents:

- a) an application requesting the letter of acceptance to studies, set out in Appendices B and C, with all fields completed, in duplicate;
- b) declaration of consent for the processing of personal data (Appendix C)
- c) copy of the document attesting the permanent residence abroad;
- d) copy and certified translation of the high-school graduation diploma or an equivalent certificate authenticated by the relevant authorities of the issuing country; the candidate's file will be accepted if the requirements provided in Appendix B according to OMEC no. 4151/24.04.2020 are met.
- e) copy and certified translation of the certificate attesting that the high-school leaving examination has been successful for the graduates of the current year;
- f) transcripts - copies and certified translations - of studies and syllabus, for candidates seeking equivalence of study periods;
- g) birth certificate - copy and certified translation;
- h) passport copy - valid at least 6 months after the date on which the letter of acceptance to studies has been issued;
- i) transcripts of records - copies and certified translations, related to the completed studies;
- j) medical certificate (in an international language) attesting that the applicant does not suffer from contagious diseases or other illnesses incompatible with the future profession; medical certificate showing the current state of health and possible personal history related to chronic diseases.

<b>Universitatea Națională de Educație Fizică și Sport din București</b>  <b>Admitere</b>	<b>ADMISSION TO 1<sup>ST</sup> CYCLE BACHELOR'S PROGRAMMES STUDY PROGRAMME IN FOREIGN LANGUAGE</b>	<b>EDIȚIA: 1 REVIZIA: 3</b>
	<b>COD M – AD – 07 - 01 - 03</b>	<b>APROBARE Hotărâre de Senat 40/28.02.2023</b>

### **Medical certificate**

The medical visit is a preliminary condition for all study programs, being materialized with FIT / UNFIT FOR PHYSICAL SPORTS EFFORT.

The medical visit can be performed at sports medicine centers in the candidate's locality/county of origin. The medical certificate must be issued by a specialist doctor with a specialization in sports medicine and must contain the mention "FIT FOR PHYSICAL SPORTS EFFORT".

The medical certificate is valid for 6 months from the date of the medical examination.

The medical examination is considered an exam, graded as accepted / rejected.

In the absence of the medical certificate and the aforementioned medical visa, the candidate is rejected.

Universitatea Națională de Educație Fizică și Sport din București  Admitere	ADMISSION TO 1 <sup>ST</sup> CYCLE BACHELOR'S PROGRAMMES STUDY PROGRAMME IN FOREIGN LANGUAGE	EDIȚIA: 1 REVIZIA: 3
	COD M – AD – 07 - 01 - 03	APROBARE Hotărâre de Senat 40/28.02.2023

## ENTRANCE EXAMINATION

### *A. FOR CITIZENS FROM MEMBER STATES OF EUROPEAN UNION, EUROPEAN ECONOMIC AREA AND SWISS CONFEDERATION*

The Central Admission Board will display at the headquarters (140 Constantin Noica Street, sector 6) and on the UNEFS website ([www.unefs.ro](http://www.unefs.ro)), at least 24 hours before the start of each test, nominal lists displaying the registered candidates, the locations and time of call.

For admission to programmes in foreign languages (French), the competitions tests are:

1. Language Proficiency Test - ELIMINATORY - candidates receive a PASS/FAIL grade

NOTE: For candidates from Member States of European Union, European Economic area and Swiss Confederation, who apply for authorized/accredited study programmes where the teaching process is conducted in foreign languages, UNEFS organizes a language proficiency test in the teaching language of the programme. The following categories are exempt from this test:

- candidates from countries where the official language is the language in which courses will be taught;
- candidates whose registration file includes study documents issued by higher education establishments from Romania or abroad, proving that their teaching language was that of the study programme;
- candidates who hold an internationally recognized language certificate (CAMBRIDGE and DELF);
- diplome d'études en langue française.

2. Regarding the admission to BACHELOR'S PROGRAMME, candidates will have to go through the following stages:

#### 1) PRELIMINARY CONDITION

The medical visit is a preliminary condition for all study programs, being materialized with FIT / UNFIT FOR PHYSICAL SPORTS EFFORT.

The medical visit can be performed at sports medicine centers in the candidate's locality/county of origin. The medical certificate must be issued by a specialist doctor with a specialization in sports medicine and must contain the mention "FIT FOR PHYSICAL SPORTS EFFORT".

The medical certificate is valid for 6 months from the date of the medical examination.

Universitatea Națională de Educație Fizică și Sport din București  Admitere	ADMISSION TO 1 <sup>ST</sup> CYCLE BACHELOR'S PROGRAMMES STUDY PROGRAMME IN FOREIGN LANGUAGE	EDIȚIA: 1 REVIZIA: 3
	COD M – AD – 07 - 01 - 03	APROBARE Hotărâre de Senat 40/28.02.2023

**The medical examination is considered an exam, graded as accepted / rejected.**

In the absence of the medical certificate and the aforementioned medical visa, the candidate is rejected.

2) **PRACTICAL TEST.** The candidate completes a general motor skills circuit, described in the Appendix

Participation in the practical test is conditioned by obtaining the medical visa FIT FOR PHYSICAL SPORTS EFFORT.

#### **WEIGHTED AVERAGE CALCULATED BETWEEN:**

a. The grade obtained in the specific motor skills practical test, which is eliminatory - weighting 50%. Additional details regarding the content of this test are presented in Appendix A. The specific motor skills test will be graded on a scale of 1 to 10. Candidates who obtain a minimum grade of 5 (five) will not be eliminated from the competition.

b. The grade obtained in the language of study within the baccalaureate exam - weighting 50%.

#### ***B. FOR NON-EU COUNTRIES***

**The admission competition involves:**

1) PASSING THE LANGUAGE PROFICIENCY TEST (if applicable); the exam will take place on **12.09.2023** at the UNEFS headquarters.

Regarding the admission to BACHELOR'S PROGRAMME, candidates will have to go through the following stages:

#### **1) PRELIMINARY CONDITION**

The medical visit is a preliminary condition for all study programs, being materialized with FIT / UNFIT FOR PHYSICAL SPORTS EFFORT.

The medical visit can be performed at sports medicine centers in the candidate's locality/county of origin. The medical certificate must be issued by a specialist doctor with a specialization in sports medicine and must contain the mention "FIT FOR PHYSICAL SPORTS EFFORT".

The medical certificate is valid for 6 months from the date of the medical examination.

**The medical examination is considered an exam, graded as accepted / rejected.**

<b>Universitatea Națională de Educație Fizică și Sport din București</b>  <b>Admitere</b>	<b>ADMISSION TO 1<sup>ST</sup> CYCLE BACHELOR'S PROGRAMMES STUDY PROGRAMME IN FOREIGN LANGUAGE</b>	<b>EDIȚIA: 1 REVIZIA: 3</b>
	<b>COD M – AD – 07 - 01 - 03</b>	<b>APROBARE Hotărâre de Senat 40/28.02.2023</b>

In the absence of the medical certificate and the aforementioned medical visa, the candidate is rejected.

2) **PRACTICAL TEST.** The candidate completes a general motor skills circuit, described in the Appendix A.

Participation in the practical test is conditioned by obtaining the medical visa **FIT FOR PHYSICAL SPORTS EFFORT.**

### **WEIGHTED AVERAGE CALCULATED BETWEEN:**

a. The grade obtained in the specific motor skills practical test, which is eliminatory - weighting 50%. Additional details regarding the content of this test are presented in Appendix A. The specific motor skills test will be graded on a scale of 1 to 10. Candidates who obtain a minimum grade of 5 (five) will not be eliminated from the competition.

b. The grade obtained in the language of study within the baccalaureate exam - weighting 50%.

Particular aspects related to the admission of citizens from non-EU countries are presented in the Specific methodology.

## **CALCULATION OF OVERALL ADMISSION AVERAGE**

The admission average is calculated with two decimals, no rounding.

Separation criteria, in the case of candidates with equal backgrounds, in order to rank in the study program:

The selection criteria for candidates are applied successively:

- a. The score obtained in the specific motor skills test.
- b. The score in the written study language test, obtained in the high school graduation exam (in case of a tie at point a).
- c. The score in the high school graduation exam (in case of a tie at point b).
- d. The score in Physical Education and Sport subject obtained in the last year of pre-university education (in case of a tie at point c).
- e. The average of the years of study in high school (in case of a tie at point d).

The enrolment capacity established in accordance with the legal provisions in force cannot be exceeded.

**Minimum overall average for passing the admission exam is 5 (five).**

Universitatea Națională de Educație Fizică și Sport din București  Admitere	ADMISSION TO 1 <sup>ST</sup> CYCLE BACHELOR'S PROGRAMMES STUDY PROGRAMME IN FOREIGN LANGUAGE	EDIȚIA: 1 REVIZIA: 3
	COD M – AD – 07 - 01 - 03	APROBARE Hotărâre de Senat 40/28.02.2023

## COMPLAINTS

Complaints regarding the **result of the admission competition** can be submitted at the **Central Admission Board** within **maximum 24 hours** from their posting.

Complaints may be related to possible *transcription errors or calculation errors*.

## FINAL RESULTS OF ENTRANCE EXAMINATION

The admission results, checked and approved by the Central Admission Board, are brought on the UNEFS website: <http://admitere.unefs.ro/>

For the academic year 2023-2024, admission to the 1<sup>st</sup> year of study is made in descending order of the results obtained by the candidates.

Admission to 1<sup>st</sup> cycle – **Bachelor's programme** strictly considers the maximum number of tuition fee places established by the UNEFS Senate.

The display of results achieved in the competitive admission involves several stages generating the following types of lists:

- a) provisional list of candidates ranked according to the admission average score;
- b) final list with the ranking of candidates after the confirmation of places, which includes the definitive and incontestable results.

The lists contain the following information:

- admitted candidates;
- rejected candidates.

The confirmation of places for candidates declared admitted to tuition places involves paying the registration fee and the first instalment of study fees within the deadline set by the UNEFS Senate and signing the study contract.

If the place is not confirmed within the set deadline, the candidate is declared rejected.

Withdrawal of the application file is possible upon personal request, with the ID card and competition ID/card. The file may be withdrawn by another person, under certified mandate from a public notary.

Admitted candidates are enrolled in the 1<sup>st</sup> year of study based on their results at the entrance examination, by decision of the UNEFS Rector.

**NOTE:** Admission terms for the academic year 2023-2024 may change depending on the instructions and orders received from MEC in the next period. They will be made known to candidates by DISPLAY.

*The Romanian authorities may impose additional public health requirements*



<b>Universitatea Națională de Educație Fizică și Sport din București</b>  <b>Admitere</b>	<b>ADMISSION TO 1<sup>ST</sup> CYCLE BACHELOR'S PROGRAMMES STUDY PROGRAMME IN FOREIGN LANGUAGE</b>	<b>EDIȚIA: 1 REVIZIA: 3</b>
	<b>COD M – AD – 07 - 01 - 03</b>	<b>APROBARE Hotărâre de Senat 40/28.02.2023</b>

*applicable to the international transport, registration process and course participation, depending on the evolution of the epidemiologic situation at the time these actions will take place.*

<b>Universitatea Națională de Educație Fizică și Sport din București</b>  <b>Admitere</b>	<b>ADMISSION TO 1<sup>ST</sup> CYCLE BACHELOR'S PROGRAMMES STUDY PROGRAMME IN FOREIGN LANGUAGE</b>	<b>EDIȚIA: 1 REVIZIA: 3</b>
	<b>COD M – AD – 07 - 01 - 03</b>	<b>APROBARE Hotărâre de Senat 40/28.02.2023</b>

### **CONFIRMATION OF THE PLACE**

The confirmation of the place is done by:

- payment of the registration fee;
- submission of registration documents;
- a submission of the contractual documents, personally by the candidate, in an envelope file;
- payment of the tuition fee - tranche I.

### **REGISTRATION OF ADMITTED CANDIDATES**

Candidates declared admitted are enrolled in the 1<sup>st</sup> year of study based on their results at the entrance examination, by decision of the UNEFS Rector.

After registration, UNEFS displays the final lists of candidates declared admitted and enrolled.

After approval of the enrolment, students are registered in the unique enrolment register, with a unique number valid for the entire schooling period in the study programme where they have been admitted.

Universitatea Națională de Educație Fizică și Sport din București  Admitere	ADMISSION TO 1 <sup>ST</sup> CYCLE BACHELOR'S PROGRAMMES STUDY PROGRAMME IN FOREIGN LANGUAGE	EDIȚIA: 1 REVIZIA: 3
	COD M – AD – 07 - 01 - 03	APROBARE Hotărâre de Senat 40/28.02.2023

*Appendix A – Practical test*

**The skill test** consists of a free- will test from the following four: SPORT GAMES, GYMNASTICS, ATHLETICS, COMBAT DISCIPLINES.

## **1. SPORT GAMES**

The candidates may choose one of the following sport games: **basketball, volleyball, handball, football**. In each game there will be two tests:

- ✓ test 1 – technical structure
- ✓ test 2 – bilateral play

**THE FINAL MARK FOR ALL SPORT GAMES**  
=  
**THE AVERAGE OF MARKS ACQUIRED AT THE TWO TESTS (without rounding off and with two decimal fraction)**

### **a. BASKETBALL**

The examination specific to the basketball game consists of two tests to which there are two marks, **the final mark** being made up of the average of the marks got at the two tests.

**TEST # 1 - TECHNICAL STRUCTURE:** is done with time keeping.



#### **Organizing the field:**

Inside the defence zone, in the corners of the restriction area, outside it, there are 4 zones (30 cm x 30 cm) which have to be touched with the foot while performing the technical structure.

Within the attack zone, in the corner of the restriction area, there is a cone which is to be rounded in dribbling on the outside.

The ball is placed on the ground, at 1m laterally to the corner of the restriction area and 1m inside the field facing its backline.

#### **Key to the diagram:**

-  movement
-  dribbling
-  throw to the basket

<b>Universitatea Națională de Educație Fizică și Sport din București</b>  <b>Admitere</b>	<b>ADMISSION TO 1<sup>ST</sup> CYCLE BACHELOR'S PROGRAMMES STUDY PROGRAMME IN FOREIGN LANGUAGE</b>	<b>EDIȚIA: 1 REVIZIA: 3</b>
	<b>COD M – AD – 07 - 01 - 03</b>	<b>APROBARE Hotărâre de Senat 40/28.02.2023</b>

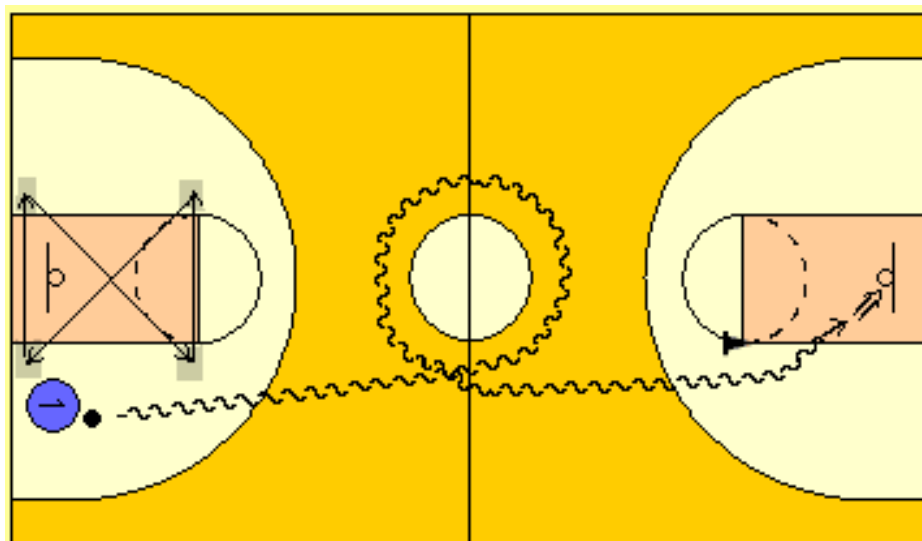

**Test description:** the candidate, from the basic position, with the foot from the sideline of the field, touching the ground in the 30 cm x 30 cm zone outside the restriction area, moves on the following route:

- movement in the basic position with added step lateral and parallel with the backline of the field and touching with the foot the 30 cm x 30 cm zone from outside of the restriction area;
- movement in the basic position with added step obliquely forward and touching with the foot the 30 cm x 30 cm area from the corner of the restriction zone;
- movement in the basic position with added step lateral on the free throwline and touching with the foot the 30 cm x 30 cm area from the corner of the restriction zone;
- movement in the basic position with added step obliquely backwards and touching with the foot the 30 cm x 30 cm area from the corner of the restriction zone;
- taking over the ball from the ground, dribbling with rounding the central circle, dribble on towards the opposite basket, while rounding on the outside the cone from the corner of the restriction area and shot a lay-up.

The technical structure is performed keeping the time. The timekeeper starts the chronometer when the candidate begins the first movement and stops it when the latter releases the ball from his/her hands to throw at the basket.

The performer may do the technical structure at will, either on the right or on the left side.

Not observing the course and the way of performing the technical structure leads to the disqualification of the candidate.

The candidate performs the course twice and the best result is registered.

**Penalties:**

Universitatea Națională de Educație Fizică și Sport din București  Admitere	ADMISSION TO 1 <sup>ST</sup> CYCLE BACHELOR'S PROGRAMMES STUDY PROGRAMME IN FOREIGN LANGUAGE	EDIȚIA: 1 REVIZIA: 3
	COD M – AD – 07 - 01 - 03	APROBARE Hotărâre de Senat 40/28.02.2023

- 0,25 sec – for not observing the movement in the basic position with added step within the restriction area (for each of the 4 movements);
- 0,25 sec – for each non touching with the foot the 30 cm x 30 cm zone in the corners of the restriction area while moving, in the basic position with added step;
- 0,25 sec – for each step deviation done by the candidate; travelling
- 0,25 sec – for each double dribbling nonconformity done by the performer;
- 1 sec – for not scoring by throwing at the basket while dribbling.

### CONVERSION TABLE OF THE TECHNICAL STRUCTURE PERFORMING TIMES CONVERTED INTO MARKS

MARK	BOYS	GIRLS
10	15"50 - 15"74	17"50 - 17"74
5	20"50 - 20"74	22"50 - 22"74

#### TEST # 2 – BILATERAL PLAY

The candidates will be examined within a 5x5 play covering the whole sportsground, having in view the individual and collective technical-tactical actions applied in opposition circumstances (*bilateral play*), namely:

- *individual tactical attack actions:*

- demarcation,
- penetration,
- offensive recovery;

- *individual tactical actions in defence:*

- man to man defense
- defensive recovery;

- *collective attack tactical actions (combinations of 2-3 players):*

- give and go.

Universitatea Națională de Educație Fizică și Sport din București  Admitere	ADMISSION TO 1 <sup>ST</sup> CYCLE BACHELOR'S PROGRAMMES STUDY PROGRAMME IN FOREIGN LANGUAGE	EDIȚIA: 1 REVIZIA: 3
	COD M – AD – 07 - 01 - 03	APROBARE Hotărâre de Senat 40/28.02.2023

## b. VOLLEYBALL

The volleyball examination comprises 2 separate tests, for which the participants receive 2 grades (one for each). The final grade is the average of the two.

**TEST NUMBER 1:** completing a course which includes 3 individual technical and tactical game actions: **serve**, **pass (forearm or overhead)** toward the setter zone, by self-throwing the ball, and **attack** by self-throwing the ball. The actions are done this way so that the candidates' execution of the skills is not dependant on another person.

Each success during the course is given 3 points, with an extra 1 by default for being present. For example, 3 successful actions x 3 points = 9 points + 1 point by default = 10 points.

### *Test description*

**Serve** towards zone 1, move in zone 5 in own field of play, **pass** (forearm or overhead) towards setter, after self-throwing the ball, move in zone 4, then **attack** in zone 5 of the opposite field by tossing the ball to oneself.

- The trial has a 12 second time limit;
- The candidate has 3 volley balls at his/her disposal (one for each action), placed wherever it is convenient for the successful completion of the trial;
- Aside from the 3 mentioned balls, the candidates have an extra one, in order to repeat an action, should they first fail it.

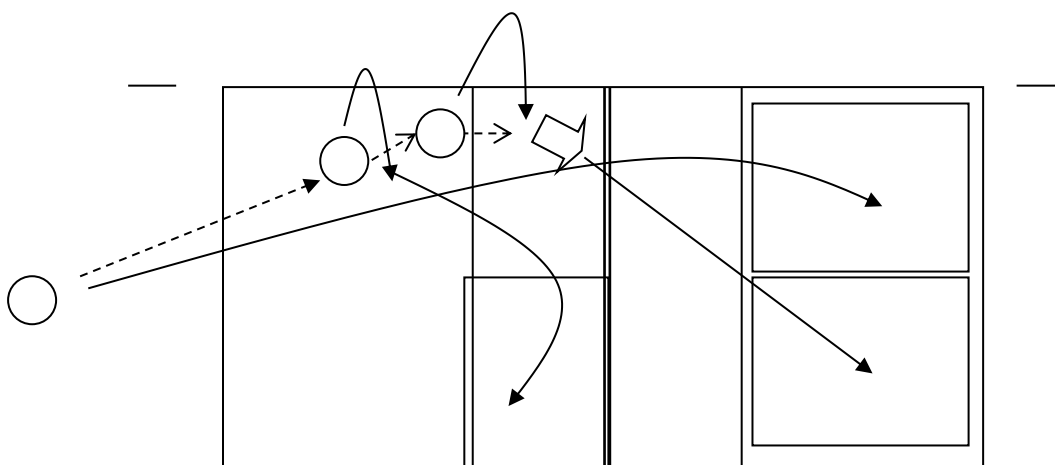

### **Mentions:**

#### a. SERVE

- The serve is executed freely, overhand or underhand, from any point of the serve zone, towards zone 1, in a marked area measuring 6 m in length and 4,5 m in width, starting from the 3 m line, to the backline of the field.

<b>Universitatea Națională de Educație Fizică și Sport din București</b>  <b>Admitere</b>	<b>ADMISSION TO 1<sup>ST</sup> CYCLE BACHELOR'S PROGRAMMES STUDY PROGRAMME IN FOREIGN LANGUAGE</b>	<b>EDIȚIA: 1 REVIZIA: 3</b>
	<b>COD M – AD – 07 - 01 - 03</b>	<b>APROBARE Hotărâre de Senat 40/28.02.2023</b>

- the serve is successful when the ball touches the marked area from the opposite field
- the serve is unsuccessful when the requirements of the execution are not met, the ball does not pass over the net, touches the antenna or lateral band, or goes out of the field play.
- the attempt to serve is viewed as an incorrect execution.

a.

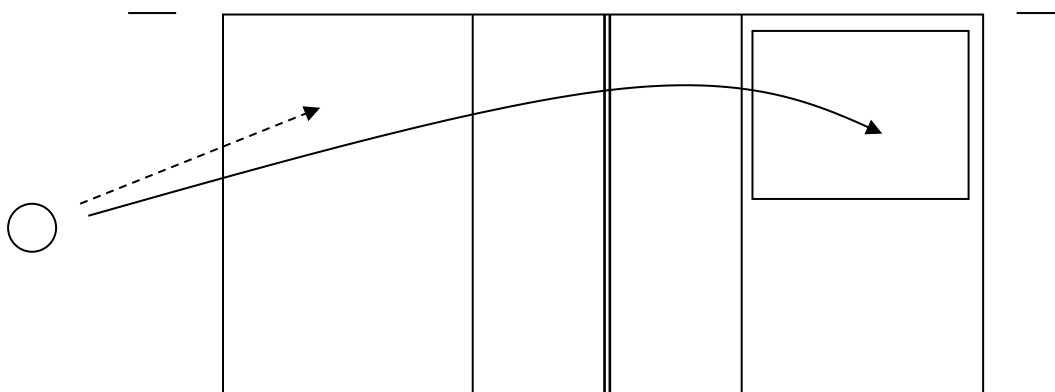

***Awarded points:***

- successful serve - 3 points;
- unsuccessful serve - 0 points
- serve outside of the marked area but in the opposite field - 1 point

**b. PASS**

- the pass is executed freely from zone 5, after self-throwing the ball, overhead or forearm, towards the net, in a marked area which measures 3 m x 4,5 m, measured up to the 3 m line.
- the pass is successful when its trajectory is optimal so that it can be set and lands in the marked area next to the net.
- the pass is unsuccessful when the ball is sent over the net in the opposite field, touches the antenna or the lateral band.
- a failed attempt to pass due to a bad toss is viewed as an incorrect execution.

b.

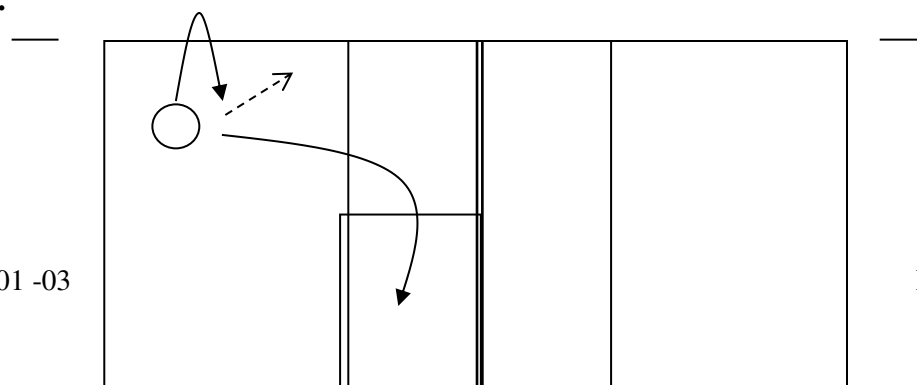

<b>Universitatea Națională de Educație Fizică și Sport din București</b>  <b>Admitere</b>	<b>ADMISSION TO 1<sup>ST</sup> CYCLE BACHELOR'S PROGRAMMES STUDY PROGRAMME IN FOREIGN LANGUAGE</b>	<b>EDIȚIA: 1 REVIZIA: 3</b>
	<b>COD M – AD – 07 - 01 - 03</b>	<b>APROBARE Hotărâre de Senat 40/28.02.2023</b>

***Awarded points:***

- successful pass - 3 points
- unsuccessful pass - 0 points
- optimal trajectory pass, but the ball touches the net next to the marked area - 2 points
- pass outside the marked area, but inside own field of play - 2 points
- low trajectory pass which does not allow a set in optimal conditions - 1 point
- pass outside the field of play - 1 point

**c. ATTACK**

- the attack is executed freely from zone 4 to zone 5 in the opposite field, by self-setting the ball, in a marked area which measures 6 m in length and 4,5 m in width, measured from the 3 m line to the backline of the field of play.
- the attack is successful when it is executed by a specific hit movement (upsurge, take off, jump, ball hit with one hand, landing), has optimal force and the ball lands inside the marked area.
- the attack is unsuccessful when the candidate touches the net, the ball stops in the net, touches the antenna or goes out of the field of play.
- a failed attempt to attack due to a bad toss is viewed as an incorrect execution

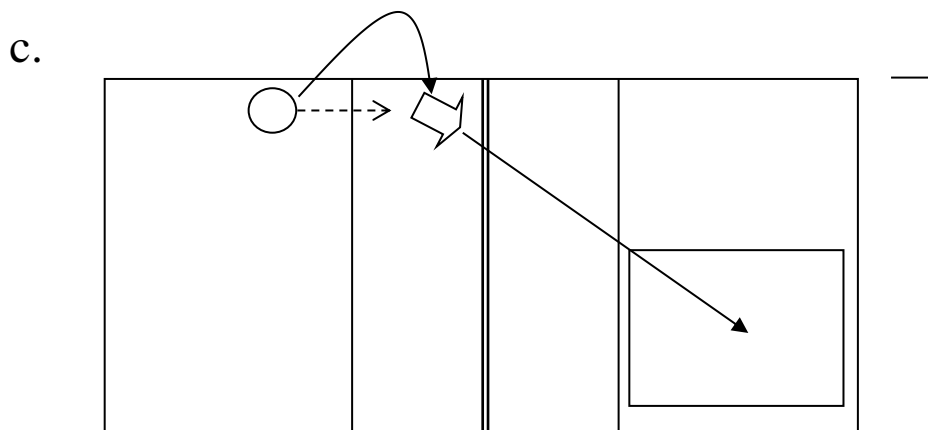

***Awarded points:***

- successful attack - 3 points
- unsuccessful attack - 0 points
- soft attack, but the ball touches inside the marked area - 2 points
- standing attack, without jumping, but the ball touches inside the marked area - 1 point.
- attack by other means besides the specific movement, but the ball touches inside the marked area - 1 point.
- attack outside the marked area, but the ball touches inside the opposite field - 1 point.



<b>Universitatea Națională de Educație Fizică și Sport din București</b>  <b>Admitere</b>	<b>ADMISSION TO 1<sup>ST</sup> CYCLE BACHELOR'S PROGRAMMES STUDY PROGRAMME IN FOREIGN LANGUAGE</b>	<b>EDIȚIA: 1 REVIZIA: 3</b>
	<b>COD M – AD – 07 - 01 - 03</b>	<b>APROBARE Hotărâre de Senat 40/28.02.2023</b>

***Extra mentions:***

- not respecting the allocated 12 seconds for the course, due to exaggerated preparation or repeating of one of the three actions is sanctioned with 1 point.
- a new execution of a failed action, without going over the allocated 12 seconds, is not sanctioned.

**TEST NUMBER 2 - BILATERAL GAME**, based on the 1st intermediary game model, without position and zone specialization, at every inning the player occupying zone 3 as setter. In these conditions, there are no zone changes during the game, each candidate keeping his zone according to the rotation; when getting to zone 3, each candidate will become a setter.

During this trial, the way the candidates play with or without the ball will be noted. More precisely, the execution of technical and tactical individual skills will be observed, as well as the way the candidates fit in the specific collective game actions (serving, receiving, attack and defence)

During this test, the candidate will be graded based on his evolution during the game, in the first and second lines, in offensive and defensive situations.

Universitatea Națională de Educație Fizică și Sport din București  Admitere	ADMISSION TO 1 <sup>ST</sup> CYCLE BACHELOR'S PROGRAMMES STUDY PROGRAMME IN FOREIGN LANGUAGE	EDIȚIA: 1 REVIZIA: 3
	COD M – AD – 07 - 01 - 03	APROBARE Hotărâre de Senat 40/28.02.2023

### c. HANDBALL

The specific examination of the handball game consists of two contest tests, where two marks are given, **the final one** being the average of the first two marks.

**TEST NO. 1 – HANDBALL TEST (timekept)**– consists in covering a route which, in the initial part, requires the fitting up of some *field guide markings* (see picture). Thus, between the 6 m line and the 9 m line *a triangle* is drawn. The base of the triangle is made up of a *straight line* (3 m) on the 6 m line and the top of the triangle is situated on the 9 m line, in front of an imaginary perpendicular raised from the middle of the triangle's base. În each of the triangle corners, a 20 cm diameter circle is drawn. At 1,5m distance laterally right to the top of the triangle, there is a ball.

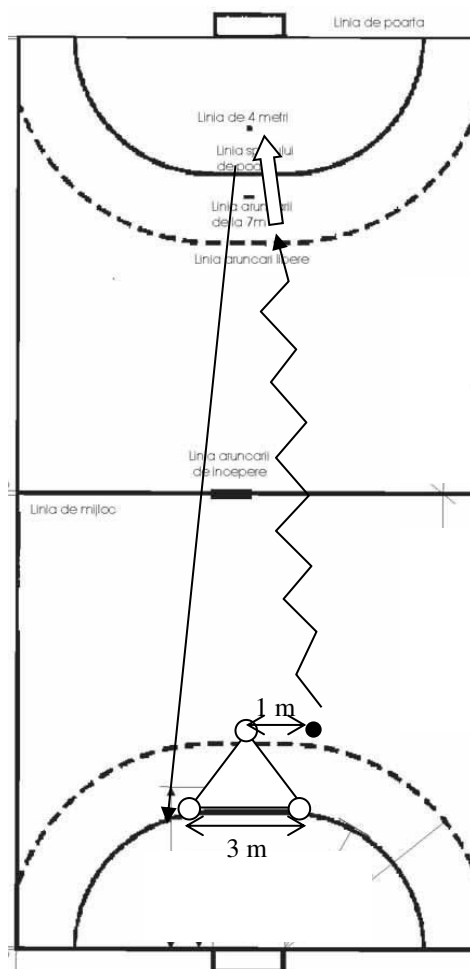

**Key to the picture:**

- - angles of the triangle
- - point of setting the ball
- ~ - multiple dribbling
- - throw to the goal
- - running without the ball

**Route description:** The candidate faces the top of the triangle and with the foot inside the circle of the right side of the triangle base; he/she moves with added steps laterally to the circle on the left side of the triangle base, then forward towards the circle in the top of the triangle and backwards to the circle in the right side of the base, performing a complete lap; after touching the circle in the point from where he/she starts, he/she runs, lifts the ball from the front of the top of the triangle, performs a multiple dribbling up to the opposite side of the field and ends by throwing the ball to the goal, between the 6 m line and 9 m line; after the throw he/she quickly returns to the 6 m line that he/she started from.

Universitatea Națională de Educație Fizică și Sport din București  Admitere	ADMISSION TO 1 <sup>ST</sup> CYCLE BACHELOR'S PROGRAMMES STUDY PROGRAMME IN FOREIGN LANGUAGE	EDIȚIA: 1 REVIZIA: 3
	COD M – AD – 07 - 01 - 03	APROBARE Hotărâre de Senat 40/28.02.2023

### Specifications:

- the test is performed *keeping the time*: the chronometer starts at the candidate's first movement and stops when he/she gets to the 6 m line where he/she started the route from;
- the test is performed twice and the best performance is registered;
- the throw to the goal is *accurately* performed, using a throwing method at will, in the above-middle side of the handball goal;
- the following mistakes are penalized:
  - ✎ steps, double dribbling, stepping the line - with 0,50 points each;
  - ✎ missing the goal when throwing the ball—with 1 point.
- The time, every candidate acquires, will be converted into the *handball testmarks*, according to the following table:

MARK	BOYS	GIRLS
10	11''7 or less	12''9 or less
5,00	14''5 – 14''3	15''7 – 15''5

### TEST NO. 2 –Bilateral play

The candidates will be examined within a play, their individual and collective technical-tactical actions being applied in circumstances of opposition (*bilateral play*):

- *individual attack actions*: the players' places in the field, catching and passing the ball while going through, passing to the line players, demarking, throwing at the goal;
- *individual defence actions*: stopping fastbreaks, returns, marking the opponent , blocking the ball thrown to the goal, attacking the opponent with the ball and taking hold of the ball from the opponent;
- *basic attack collective actions*: simple and double crossings, blockings, screenings, wing crossings, blocking and leaving the blocking;
- *basic defence collective actions*: change of opponents, doubling, cooperation with the goalkeeper and the defence against the penalty throws.

Universitatea Națională de Educație Fizică și Sport din București  Admitere	ADMISSION TO 1 <sup>ST</sup> CYCLE BACHELOR'S PROGRAMMES STUDY PROGRAMME IN FOREIGN LANGUAGE	EDIȚIA: 1 REVIZIA: 3
	COD M – AD – 07 - 01 - 03	APROBARE Hotărâre de Senat 40/28.02.2023

### d. FOOTBALL (boys and girls)

The examination, specific to the football game consists of two contest tests, where two marks are given, **the final one** being the average of the first two marks.

#### TEST NO. 1 - ROUTE (time kept)

##### *Route description:*

- the candidate starts at 33,5 m distance from the goal, takes over the ball with the sole on the moving direction, with the upper foot by cushioning or with the inner foot by cushioning from self ball throw (the ball is thrown up to the head level), guides the ball among 4 cones (3 m distance between them) and ends with a shot to the goal (kicking ball procedure at will) from outside the penalty area (the ball must get into the goal). The start line is at 3 m distance from the first cone and the finishing area (between the last cone and the penalty area) has a 5 m length.

##### **Key to the diagram:**

- performer;
- ⊂ ball taking over;
- ~> ball guiding;
- ⇒ finishing (shot to the goal).

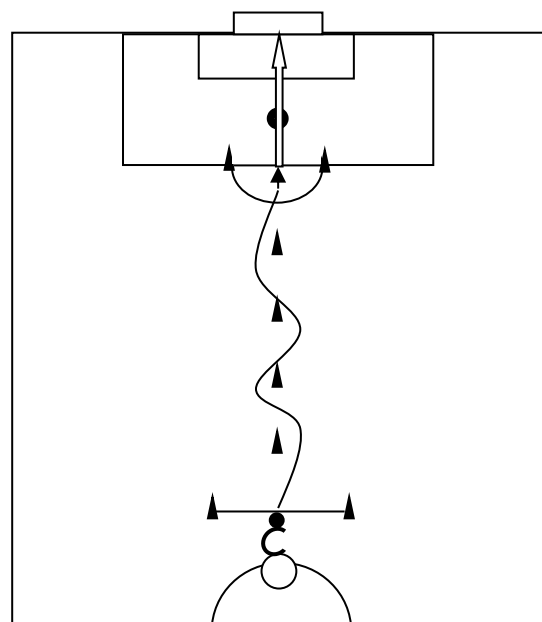

##### **Specifications:**

- the test is accomplished keeping the time; the chronometer starts when the candidate takes over the ball and stops when he/she shoots to the goal;
- the candidate is entitled to two attempts, the best one being registered;
- the time acquired by each candidate will be converted into *football testmarks*, according to the following table:

Universitatea Națională de Educație Fizică și Sport din București  Admitere	ADMISSION TO 1 <sup>ST</sup> CYCLE BACHELOR'S PROGRAMMES STUDY PROGRAMME IN FOREIGN LANGUAGE	EDIȚIA: 1 REVIZIA: 3
	COD M – AD – 07 - 01 - 03	APROBARE Hotărâre de Senat 40/28.02.2023

MARK	BOYS	GIRLS
10	4''51 - 4''75	5''51 - 5''75
5	5''76 - 6''	6''76 - 7''

### Penalties:

- the avoidance of a cone, knocking it down, shooting to the goal before the last cone and going beyond the goal shooting line are penalized with 0,50 seconds;
- not respecting the route leads to disqualification of the candidate;
- sending the ball outside the goal, inclusively hitting the horizontal/cross bar are penalized with 0,50 seconds.

### TEST NO. 2 - BILATERAL PLAY ON SHORT GROUND (boys and girls)

Candidates will be graded from 1 to 10 in a bilateral 6vs6 game over 30 minutes and will be judged on the following technical execution and tactical actions:

#### *I. for field players:*

- *in attack*—kicking the ball and hitting it with the head;
  - taking over of the ball;
  - guiding the ball;
  - deceiving movement;
  - protecting the running ball;
  - delimitation;
  - individual overtaking;
  - the one-two pass;
  - crossing.
- *in defence*—dispossessing the opponent of the ball;
  - blocking in the 16m square line;
  - doubling;
  - pressing.

#### *II. for goalkeepers:*

The candidates who ask and play for this position will be judged for the *correctness* and *efficiency* of the performances and of the technical-tactical actions which make *the content of the goalkeeper play* both in attack and in defence.

Universitatea Națională de Educație Fizică și Sport din București  Admitere	ADMISSION TO 1 <sup>ST</sup> CYCLE BACHELOR'S PROGRAMMES STUDY PROGRAMME IN FOREIGN LANGUAGE	EDIȚIA: 1 REVIZIA: 3
	COD M – AD – 07 - 01 - 03	APROBARE Hotărâre de Senat 40/28.02.2023

## GYMNASTICS

Within the entrance examination the candidates who choose "Gymnastics" for the physical education will perform two compulsory tests:

**TEST NO.1: floor exercise – free will;** this may consist of value elements chosen from the artistic or/and rhythmical gymnastics. The value of the difficulty of the elements on combinations must totalize 9 points. This must be taken from the specific charts annexed in the "Admittance booklet". An ex officio point is given for the maximum score – 10.

**TEST NO.2: vault over gymnastics apparatus – gymnastics equipment (vaulting horse or gymnastics box]placed crosswise, at will.** There are suggested 2 vaults both for boys and for girls. Both are quoted with the 9 as a starting mark.

*The final result at "gymnastics" discipline will be made up of the average of the 2 marks acquired at the floor and the vault tests.*

### SPECIFICATIONS REGARDING THE TESTS:

- **For every test the valuation will begin with 10** – considered as a starting mark. For every test this is made up of:
  - 1 point ex officio + 9 points – standing for the value** of the whole element difficulties comprised in the free will floor exercise (test 1);
  - 1 point ex officio + 9 points the value of the vault** the candidate chose (test 2);
  - From each starting mark, the penalizations are diminished for the execution, when needed.**
- For **test 1** the elements from the table below are chosen, so that the accumulated values should be **9 points**.

### Comments

During the exercise, the elements chosen by the candidates have to find themselves within the content of the exercise **only once!** No repetition of an element or gymnastic combination will be taken into consideration. Within the exercise, the candidates must have an element of the 3 value categories: one of 3 points, one of 2 points and one of 1 point.



Universitatea Națională de Educație Fizică și Sport din București  Admitere	ADMISSION TO 1 <sup>ST</sup> CYCLE BACHELOR'S PROGRAMMES STUDY PROGRAMME IN FOREIGN LANGUAGE	EDIȚIA: 1 REVIZIA: 3
	COD M – AD – 07 - 01 - 03	APROBARE Hotărâre de Senat 40/28.02.2023

### ! PAY ATTENTION!





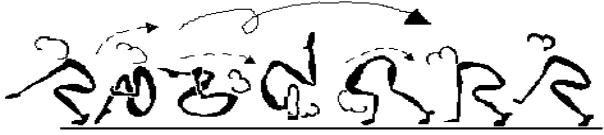

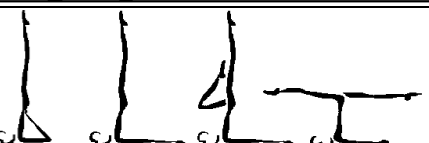

- *The elements suggested for the test 1 – floor exercise address to everybody, boys and girls (even if the drawing shows a boy or a girl);*
- *If the requirements of logical and fluent construction of elements lead to initial and final positions different from those in the drawing, the elements are taken into consideration;*
- *The candidates are recommended to choose elements of various values, so that the sum total of their values should be 9 points. In case the sum is smaller, the starting mark will also be lower and the possibility of getting the best mark is out of the question.*

#### Guiding examples of combining the values:

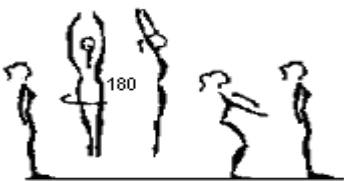
- (4 elements x 1 point) + (1 element x 2 points) + (1 element x 3 points) = 9 points;
- (1 element x 1 point) + (1 element x 2 points) + (2 elements x 3 points) = 9 points;
- (2 elements x 1 point) + (2 elements x 2 points) + (1 element x 3 points) = 9 points;

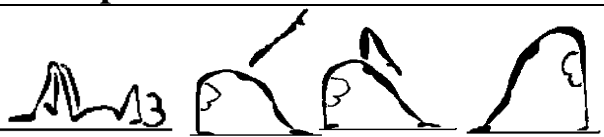



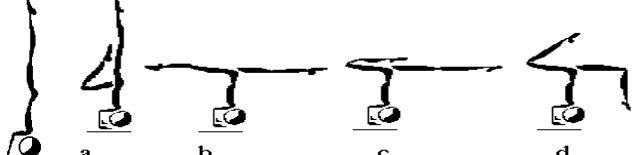



<b>TABLE WITH THE ELEMENTS FOR TEST 1</b>		
No.	Name of the element	Value 1 point
1.	Forward tuck roll	
2.	Backward tuck roll	
3.	Backward straddle roll	
4.	Candlestick(variants )	

<b>Universitatea Națională de Educație Fizică și Sport din București</b>  <b>Admitere</b>	<b>ADMISSION TO 1<sup>ST</sup> CYCLE BACHELOR'S PROGRAMMES</b> <b>STUDY PROGRAMME IN FOREIGN LANGUAGE</b>	<b>EDIȚIA: 1</b> <b>REVIZIA: 3</b>
	<b>COD M – AD – 07 - 01 - 03</b>	<b>APROBARE</b> <b>Hotărâre de Senat</b> <b>40/28.02.2023</b>



5.	Knee scale	
6.	Half split	
7.	Stretched jump with 1/2 turn (180°)	
8.	Tuck jump (grouped)	
9.	Passé jump	
<b>Value 2 points</b>		
1.	Bridge from below (variants)	
2.	Scale forward (variants)	
3.	Roll forward from stand to straddle	
4.	Handstand with coming back	
5.	Headstand (variants)	



<b>Universitatea Națională de Educație Fizică și Sport din București</b>  <b>Admitere</b>	<b>ADMISSION TO 1<sup>ST</sup> CYCLE BACHELOR'S PROGRAMMES</b> <b>STUDY PROGRAMME IN FOREIGN LANGUAGE</b>	<b>EDIȚIA: 1</b> <b>REVIZIA: 3</b>
	<b>COD M – AD – 07 - 01 - 03</b>	<b>APROBARE</b> <b>Hotărâre de Senat</b> <b>40/28.02.2023</b>

6.	Headstand from the straddle position, roll forward to tuck	
7.	Straight jump with 360° turn	
8.	Body wave forward (variants)	
9.	Scissors jump forward with extended legs, arms up	
<b>Value 3 points</b>		
1.	Bridge from above with return	
2.	Split with the right/left leg forward/ lateral	
3.	Roll forward from stand to pike	
4.	Cartwheel from stand with the right/left shoulder towards the execution direction	

Universitatea Națională de Educație Fizică și Sport din București  Admitere	ADMISSION TO 1 <sup>ST</sup> CYCLE BACHELOR'S PROGRAMMES STUDY PROGRAMME IN FOREIGN LANGUAGE	EDIȚIA: 1 REVIZIA: 3
	COD M – AD – 07 - 01 - 03	APROBARE Hotărâre de Senat 40/28.02.2023

5.	Handstand to bridge-up to stand	
6.	Handstand with roll forward to tuck	
7.	Handstand with roll forward to straddle	

- For the **test 2**, one of the vaults further down will be chosen for boys and girls:

**2.1 Straddle jump over the gymnastics equipment (vaulting horse) (height – 1,00 m.) and landing in stand with knees slightly bent and arms laterally.**

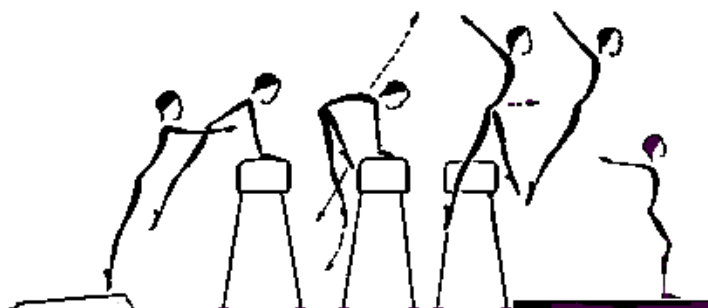

**2.2 Jump in tuck position support on the gymnastics box placed transversally and jump with extension fly landing in stand with arms laterally (height – 1,15 m.).**

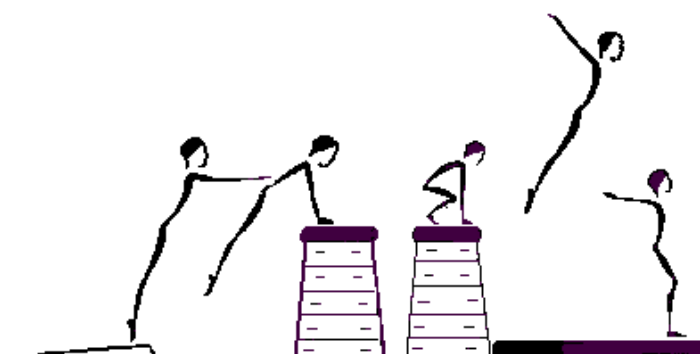

Universitatea Națională de Educație Fizică și Sport din București  Admitere	ADMISSION TO 1 <sup>ST</sup> CYCLE BACHELOR'S PROGRAMMES STUDY PROGRAMME IN FOREIGN LANGUAGE	EDIȚIA: 1 REVIZIA: 3
	COD M – AD – 07 - 01 - 03	APROBARE Hotărâre de Senat 40/28.02.2023



## PAY ATTENTION!

- *The vaults suggested for the test 2 address to everyone, boys and girls (even if the drawings show boys).*

FLOOR PENALTIES				
Not granting the element value	0,5 points	0,3 points	0,2 points	0,1 points
<i>Uncontrolled, illogical, non gymnical execution</i>	<i>Fall/repetition; execution without poise and specific strain along the exercise</i>	<i>Great unbalance Great mistakes of technique and poise</i>	<i>Turning away from the direction of execution Average technique and poise mistakes</i>	<i>Small mistakes of poise</i>
VAULT PENALTIES				
Not granting the jump value	0,5 points	0,3 points	0,2 points	0,1 points
<i>Not performing the jump Performing another jump</i>	<i>Fall/floor support in the second part of the jump</i>	<i>Hitting the apparatus Support on only one hand on the apparatus Great poise mistakes</i>	<i>Touching the apparatus Small amplitude in flight II Hand support on the floor while landing Average poise mistakes</i>	<i>Landing in stand tuck Landing in stand with legs astride Steps after landing Small poise mistakes</i>

## SPECIFICATIONS REGARDING THE CANDIDATE'S PERFORMANCE, PRESENTATION AND JUDGMENT

- ✿ During the examination, every candidate is entitled to a **single presentation (trial)** of the free will exercise and to a **single vault**.

Universitatea Națională de Educație Fizică și Sport din București  Admitere	<b>ADMISSION TO 1<sup>ST</sup> CYCLE BACHELOR'S  PROGRAMMES  STUDY PROGRAMME IN FOREIGN LANGUAGE</b>	<b>EDIȚIA: 1  REVIZIA: 3</b>
	<b>COD M – AD – 07 - 01 - 03</b>	<b>APROBARE  Hotărâre de Senat  40/28.02.2023</b>

- ✿ The beginning of every exercise is preceded by the presentation. It is compulsory.
- ✿ **The judgment** is made according with the Gymnastics arbitration usage, taking into account the correctness of the performance, the fluency and the logical binding of the floor exercise and the correctness of the chosen vault, registering the possible penalties.
- ✿ The allowed **outfit** for the candidates: shorts/tights, undervest/jumper, gymnastics suit, gymnastics slippers/socks/barefoot, as the candidate prefers. The outfit must be decent and allow the light performance of the chosen elements and vault.

✿ **Mark**

**For the test no.1:**

Floor mark = 10 – the penalty sum total (when needed)

**For the test no.2:**

Vault mark = 10 – the penalty sum total (when needed)

**FINAL MARK AT GYMNASTICS**  
=

***THE AVERAGE OF THE MARKS ACQUIRED AT THE TWO TESTS***  
*(no rounding off and with two decimals)*

Universitatea Națională de Educație Fizică și Sport din București  Admitere	ADMISSION TO 1 <sup>ST</sup> CYCLE BACHELOR'S PROGRAMMES STUDY PROGRAMME IN FOREIGN LANGUAGE	EDIȚIA: 1 REVIZIA: 3
	COD M – AD – 07 - 01 - 03	APROBARE Hotărâre de Senat 40/28.02.2023

## ATHLETICS

The candidates will be valuated on the basis of two tests:

**TEST NO.1 – COMPULSORY TEST – speed running on the 50 m distance**

**TEST NO.2 – TEST AT OPTION among:**

- a. long jump
- b. shot put
- c. endurance running (800 m girls, 1500 m boys)

### 1. Speed running on 50 m distance:

- only once, stand start;
- the candidates leaves (freely), the chronometer starting at his/her first movement.

<i>Mark</i>	<i>1</i>	<i>2</i>	<i>3</i>	<i>4</i>	<i>5</i>	<i>6</i>	<i>7</i>	<i>8</i>	<i>9</i>	<i>10</i>
Boys (seconds)	6.9	6.8	6.7	6.6	6.5	6.4	6.3	6.2	6.1	5.9
Girls (seconds)	7.9	7.8	7.7	7.6	7.5	7.4	7.3	7.2	7.1	6.9

### 2. a. Long jump:

- there will be two attempts, taking into consideration the best one;
- the step will be executed freely, in a 1 m sided square, situated at 1 m distance to the jump pit;
- it will be measured from the foot print, left within the square up to the last trace from the jump pit.

<i>Mark</i>	<i>1</i>	<i>2</i>	<i>3</i>	<i>4</i>	<i>5</i>	<i>6</i>	<i>7</i>	<i>8</i>	<i>9</i>	<i>10</i>
Boys (meters)	4.70	4.80	4.90	5.00	5.10	5.20	5.30	5.50	5.75	6.00
Girls (meters)	3.70	3.80	3.90	4.00	4.10	4.20	4.30	4.50	4.75	5.00

<b>Universitatea Națională de Educație Fizică și Sport din București</b>  <b>Admitere</b>	<b>ADMISSIONTO1<sup>ST</sup>CYCLE BACHELOR'S PROGRAMMES STUDY PROGRAMME IN FOREIGN LANGUAGE</b>	<b>EDIȚIA: 1 REVIZIA: 3</b>
	<b>COD M – AD – 07 - 01 - 03</b>	<b>APROBARE Hotărâre de Senat 40/28.02.2023</b>

The calculation of the intermediate grades, in the long jump, will be done according to the following tables:

MARK	BOYS	GIRLS
	Performance (m)	Performance (m)
<b>10</b>	<b>6.00</b>	<b>5.00</b>
9.80	5.95	4.95
9.60	5.90	4.90
9.40	5.85	4.85
9.20	5.80	4.80
<b>9.00</b>	<b>5.75</b>	<b>4.75</b>
8.80	5.70	4.70
8.60	5.65	4.65
8.40	5.60	4.60
8.20	5.55	4.55
<b>8.00</b>	<b>5.50</b>	<b>4.50</b>
7.80	5.46	4.46
7.60	5.42	4.42
7.40	5.38	4.38
7.20	5.34	4.34
<b>7.00</b>	<b>5.30</b>	<b>4.30</b>
6.80	5.28	4.28
6.60	5.26	4.26
6.40	5.24	4.24
6.20	5.22	4.22
<b>6.00</b>	<b>5.20</b>	<b>4.20</b>
5.80	5.18	4.18
5.60	5.16	4.16
5.40	5.14	4.14
5.20	5.12	4.12
<b>5.00</b>	<b>5.10</b>	<b>4.10</b>
4.80	5.08	4.08
4.60	5.06	4.06
4.40	5.04	4.04
4.20	5.02	4.02
<b>4.00</b>	<b>5.00</b>	<b>4.00</b>
3.80	4.98	3.98
3.60	4.96	3.96
3.40	4.94	3.94
3.20	4.92	3.92
<b>3.00</b>	<b>4.90</b>	<b>3.90</b>
2.80	4.88	3.88
2.60	4.86	3.86
2.40	4.84	3.84
2.20	4.82	3.82
<b>2.00</b>	<b>4.80</b>	<b>3.80</b>
1.80	4.78	3.78
1.60	4.76	3.76
1.40	4.74	3.74

Universitatea Națională de Educație Fizică și Sport din București  Admitere	<b>ADMISSIONTO1<sup>st</sup>CYCLE BACHELOR'S PROGRAMMES STUDY PROGRAMME IN FOREIGN LANGUAGE</b>	<b>EDIȚIA: 1 REVIZIA: 3</b>
	<b>COD M – AD – 07 - 01 - 03</b>	<b>APROBARE Hotărâre de Senat 40/28.02.2023</b>

1.20	4.72	3.72
<b>1.00</b>	<b>4.70</b>	<b>3.70</b>

## 2.b. Shot put

- the weight of the ball is 4 kg for girls and 7,260 kg for boys;
- two attempts will be made taking into consideration the best performance;
- the ball will be thrown from the statutory circle (2,135 m diameter) beginning from a stationary position.

<i>Mark</i>	<i>1</i>	<i>2</i>	<i>3</i>	<i>4</i>	<i>5</i>	<i>6</i>	<i>7</i>	<i>8</i>	<i>9</i>	<i>10</i>
Boys (meters)	6.00	6.50	7.00	7.50	8.00	8.30	8.60	8.90	9.20	9.50
Girls (meters)	5.00	5.50	6.00	6.50	7.00	7.30	7.60	7.90	8.20	8.50

The calculation of intermediate marks for the shot put test will be done according to the following tables:

MARK	BOYS	GIRLS
	Performance (m)	Performance (m)
<b>10</b>	<b>9.50</b>	<b>8.50</b>
9.80	9.44	8.44
9.60	9.38	8.38
9.40	9.32	8.32
9.20	9.26	8.26
<b>9.00</b>	<b>9.20</b>	<b>8.20</b>
8.80	9.14	8.14
8.60	9.08	8.08
8.40	9.02	8.02
8.20	8.96	7.96
<b>8.00</b>	<b>8.90</b>	<b>7.90</b>
7.80	8.84	7.84
7.60	8.78	7.78
7.40	8.72	7.72
7.20	8.66	7.66
<b>7.00</b>	<b>8.60</b>	<b>7.60</b>
6.80	8.54	7.54
6.60	8.48	7.48
6.40	8.42	7.42
6.20	8.36	7.36
<b>6.00</b>	<b>8.30</b>	<b>7.30</b>
5.80	8.24	7.24
5.60	8.18	7.18

Universitatea Națională de Educație Fizică și Sport din București  Admitere	<b>ADMISSION TO 1<sup>ST</sup> CYCLE BACHELOR'S PROGRAMMES STUDY PROGRAMME IN FOREIGN LANGUAGE</b>	<b>EDIȚIA: 1 REVIZIA: 3</b>
	<b>COD M – AD – 07 - 01 - 03</b>	<b>APROBARE Hotărâre de Senat 40/28.02.2023</b>

5.40	8.12	7.12
5.20	8.06	7.06
<b>5.00</b>	<b>8.00</b>	<b>7.00</b>
4.80	7.90	6.90
4.60	7.80	6.80
4.40	7.70	6.70
4.20	7.60	6.60
<b>4.00</b>	<b>7.50</b>	<b>6.50</b>
3.80	7.40	6.40
3.60	7.30	6.30
3.40	7.20	6.20
3.20	7.10	6.10
<b>3.00</b>	<b>7.00</b>	<b>6.00</b>
2.80	6.90	5.90
2.60	6.80	5.80
2.40	6.70	5.70
2.20	6.60	5.60
<b>2.00</b>	<b>6.50</b>	<b>5.50</b>
1.80	6.40	5.40
1.60	6.30	5.30
1.40	6.20	5.20
1.20	6.10	5.10
<b>1.00</b>	<b>6.00</b>	<b>5.00</b>

**2. c. Endurance running - girls/ 800 m; boys/ 1500 m**  
- running starts at order.

<b>Mark</b>	<b>1</b>	<b>2</b>	<b>3</b>	<b>4</b>	<b>5</b>	<b>6</b>	<b>7</b>	<b>8</b>	<b>9</b>	<b>10</b>
<b>Boys (min)</b>	6.10	6.00	5.50	5.40	5.30	5.20	5.10	5.00	4.50	4.40
<b>Girls (min)</b>	4.10	4.00	3.50	3.40	3.30	3.20	3.10	3.00	2.50	2.40

The calculation of the intermediate grades for the endurance running test will be done according to the following tables:

<b>MARK</b>	<b>BOYS</b>	<b>GIRLS</b>
	<b>Performance (min.)</b>	<b>Performance (min.)</b>
<b>10</b>	<b>4.40</b>	<b>2.40</b>
9.80	4.42	2.42
9.60	4.44	2.44
9.40	4.46	2.46
9.20	4.48	2.48
<b>9.00</b>	<b>4.50</b>	<b>2.50</b>
8.80	4.52	2.52
8.60	4.54	2.54
8.40	4.56	2.56



Universitatea Națională de Educație Fizică și Sport din București  Admitere	ADMISSION TO 1 <sup>ST</sup> CYCLE BACHELOR'S PROGRAMMES STUDY PROGRAMME IN FOREIGN LANGUAGE	EDIȚIA: 1 REVIZIA: 3
	COD M – AD – 07 - 01 - 03	APROBARE Hotărâre de Senat 40/28.02.2023

8.20	4.58	2.58
<b>8.00</b>	<b>5.00</b>	<b>3.00</b>
7.80	5.02	3.02
7.60	5.04	3.04
7.40	5.06	3.06
7.20	5.08	3.08
<b>7.00</b>	<b>5.10</b>	<b>3.10</b>
6.80	5.12	3.12
6.60	5.14	3.14
6.40	5.16	3.16
6.20	5.18	3.18
<b>6.00</b>	<b>5.20</b>	<b>3.20</b>
5.80	5.22	3.22
5.60	5.24	3.24
5.40	5.26	3.26
5.20	5.28	3.28
<b>5.00</b>	<b>5.30</b>	<b>3.30</b>
4.80	5.32	3.32
4.60	5.34	3.34
4.40	5.36	3.36
4.20	5.38	3.38
<b>4.00</b>	<b>5.40</b>	<b>3.40</b>
3.80	5.42	3.42
3.60	5.44	3.44
3.40	5.46	3.46
3.20	5.48	3.48
<b>3.00</b>	<b>5.50</b>	<b>3.50</b>
2.80	5.52	3.52
2.60	5.54	3.54
2.40	5.56	3.56
2.20	5.58	3.58
<b>2.00</b>	<b>6.00</b>	<b>4.00</b>
1.80	6.02	4.02
1.60	6.04	4.04
1.40	6.06	4.06
1.20	6.08	4.08
<b>1.00</b>	<b>6.10</b>	<b>4.10</b>

### ATHLETICS FINAL MARK

=

***THE AVERAGE OF THE TWO PERFORMED TESTS***  
*(no rounding off and with two decimals)*

Universitatea Națională de Educație Fizică și Sport din București  Admitere	ADMISSION TO 1 <sup>ST</sup> CYCLE BACHELOR'S PROGRAMMES STUDY PROGRAMME IN FOREIGN LANGUAGE	EDIȚIA: 1 REVIZIA: 3
	COD M – AD – 07 - 01 - 03	APROBARE Hotărâre de Senat 40/28.02.2023

#### 4. COMBAT DISCIPLINES

##### TEST NO. 1 – Specific techniques of attack and defence

1.	Straight front and back arms (oi tsuki-gyaku tsuki)	1 point
2.	Side hit with the front and back arms (seiken mawashi tsuki)	1 point
3.	Uppercut with the front and back arm (shita uchi)	1 point
4.	Upper level defence (jodan)	1 point
5.	Medium level defence (chudan)	1 point
6.	Lower level defence (gedan)	1 point
7.	Straight kick -mae geri- with the front and back foot	1 point
8.	Round kick- mawashi geri- with the front and back foot	1 point
9.	Turn kick (ushiro ura mawashi geri) with the front and back foot	1 point

**The first test mark** is made up of the sum of the points acquired plus 1 point ex officio.

**NOTE:** the performances are demonstrated ambilaterally, on a high, medium or low level, at the examination committee request.

##### TEST NO. 2 - Throwing, immobilization, luxation, dislocation, strangulation (at will)

1.	Arm throwing	1 point
2.	Hip throwing	1 point
3.	Leg throwing	1 point
4.	Sideways sacrifice throwing	1 point
5.	Back sacrifice throwing	1 point
6.	Cross, sideways or extension immobilization	1 point
7.	Strangling from behind	1 point
8.	Strangling from the front	1 point
9.	Straight elbow dislocation	1 point

**The mark for the Test 2** is made up of the sum of the acquired points plus 1 point ex officio.

**NOTE:** the performances are demonstrated ambilaterally, at the examination committee request.

The candidates will present themselves with the outfit suitable to performing the test.

#### THE FINAL MARK AT COMBAT DISCIPLINES

=

#### THE AVERAGE OF THE TWO TEST MARKS

(no rounding off and with two decimals)

Universitatea Națională de Educație Fizică și Sport din București  Admitere	ADMISSIONTO1 <sup>ST</sup> CYCLE BACHELOR'S PROGRAMMES STUDY PROGRAMME IN FOREIGN LANGUAGE	EDIȚIA: 1 REVIZIA: 3
	COD M – AD – 07 - 01 - 03	APROBARE Hotărâre de Senat 40/28.02.2023

## Appendix B

### List of high school diplomas recognized by the Ministry of Education for foreign citizens to enroll in university studies.

Country	Diploma
Afganistan	Baccalaureat Certificate/ 12 Grade Graduation Certificate
Albania	Deftese Pjekurie (Maturity Certificate)
Algeria	Diplôme de Bachelier de l'enseignement secondaire général + Relevé de notes du baccalauréat
South Africa	National Senior Certificate
Angola	Certificado de Ensino Medio/ Certificado de Estudios Pre-Universitarios/ Habilitações
Argentina	Bachiller/ Bachillerato
Armenia	From 2018: Atestat mijnakarg (Iriv) andhanur krtutyany Before 2018: Attestat/ Certificate of maturity "Hasunutian Vkaiakan"/ Attestat midzinakarg krtoitjan
Saudi Arabia	General Secondary Education Certificate (Shahadat Al- Thanawiyah)
Australia, Capital Territory	ACT Year 12 Certificate
Australia, New South Wales	Higher School Certificate + Examination with Results
Australia, Queensland	Queensland Senior Certificate/ Queensland Certificate of Education
Australia, South Australia	South Australian Certificate of Education
Australia, Northern Territory	Northern Territory Certificate of Education
Australia, Tasmania	Tasmanian Certificate of Education
Australia, Western	Western Australian Certificate of Education
Australia, Victoria	Victorian Certificate of Education
Austria	Reifezeugnis/ Reifeprüfungszeugnis/ Reife-und Diplomprüfungszeugnis
Azerbaijan	Orta Tahsil Haqqında Attestat/ Orta mekteb attestati/ Svidetel'stvo/o Srednem Obrazovanii
Bahamas	Bahamas General Certificate of Education
Bahrain	Tawjihiya (Secondary School Leaving Certificate)
European Baccalaureate International Baccalaureate	Diplôme du Baccalauréat Europeen/Europeisk Baccalaureat Diploma International Baccalaureate Diploma
Bangladesh	Higher Secondary School Certificate/ Intermediate
Belarus	Atestat ab agul'naj sjarednjaj adukatsyi/ Attestat o (Obschem) Srednem Obrazovanii
Belgium	Diploma van secundair onderwijs/ Certificat d'Enseignement Secondaire Supérieur (C.E.S.S.)/ Abschlusszeugnis der Oberstufe des Sekundarunterrichts (allgemein bildender und künstlerischer Sekundarunterricht)
Benin	Diplôme de Bachelier de l' Enseignement Moyen Général (1984-1991)/

<b>Universitatea Națională de Educație Fizică și Sport din București</b>  <b>Admitere</b>	<b>ADMISSIONTO1<sup>ST</sup>CYCLE BACHELOR'S PROGRAMMES STUDY PROGRAMME IN FOREIGN LANGUAGE</b>	<b>EDIȚIA: 1 REVIZIA: 3</b>
	<b>COD M – AD – 07 - 01 - 03</b>	<b>APROBARE Hotărâre de Senat 40/28.02.2023</b>

	Diplôme de Bachellier de l' Enseignement de Second Degré (1991-)/ Baccalauréat de l'Enseignement Secondaire + relevé des notes Releve des notes
Bhutan	Bhutan Higher Secondary Education Certificate (Class XII)/ Indian School Certificate examination
Bolivia	Diploma Bachiller en Humanidades
Bosnia and Herzegovina	Diploma o polozenom završnom ispitu/ Diploma o Završenoj Srednjoj Skoli/ Matura/ Svjedodžba o Završenoj Srednjoj Skoli (Secondary School Leaving Certificate)
Botswana	Cambridge Higher Overseas School Certificate with GCE A Levels/ Botswana General Certificate of Secondary Education
Brazil	Diploma de Ensino Médio/ Certificado de Conclusao do Ensino Medio Supletivo/ Certificado de Conclusao de Segundo Grau
Brunei Darussalam	Brunei Cambridge Advanced Level Certificate of Education/ Brunei Matriculation Examination Certificate
Bulgaria	Diploma za Sredno Obrazovanie
Burkina Faso	Diplôme de Bachiller/ Baccalauréat de l'Enseignement du Second Degré + Relevé des notes
Burma (Myanmar)	Basic Education High School Examination/ Standard X Examination (Matriculation)
Burundi	Diplôme d'Etat/ Diplôme des Humanités Générales/ Certificat Homologue des Humanités Complètes
Cambodgia	Certificate of Upper Secondary Education/ Senior High School Certificate/ Attestation de Fin d'Etudes Secondaires de l'Enseignement General
Cameroun – British system	Cameroon GCE Ordinary Level Examinations + Cameroon GCE Advanced Level Examinations
Cameroun – French system	Baccalaureat de l'Enseignement Secondaire/ Baccalauréat Technique, Brevet de Technicien l'Enseignement Secondaire
Canada, Alberta	Alberta High School Diploma/ Advanced High School Diploma/ General High School Diploma
Canada, British Columbia	Secondary School Diploma/ Senior Secondary Graduation Diploma (Dogwood Diploma)/ Certificate of Graduation
Canada, Manitoba	High School Graduation Diploma/ Final Secondary School Leaving Certificate
Canada, New Brunswick	High School Graduation Diploma/ Diplôme de Fin d'Etudes Secondaires
Canada, New Foundland and Labrador	High School Graduation Diploma
Canada, North West Territories	NWT High School Diploma
Canada, Nova Scotia	Nova Scotia High School Graduation Diploma/ High School Completion Certificate
Canada, Nunavut	High School Graduation Diploma/ School Leaving Certificate
Canada, Ontario	Ontario Secondary School Diploma (OSSD)/ Secondary School Graduation Diploma (SSGD)/ Secondary School Honours Graduation Diploma (SSHGD)

<b>Universitatea Națională de Educație Fizică și Sport din București</b>  <b>Admitere</b>	<b>ADMISSION TO 1<sup>ST</sup> CYCLE BACHELOR'S PROGRAMMES STUDY PROGRAMME IN FOREIGN LANGUAGE</b>	<b>EDIȚIA: 1 REVIZIA: 3</b>
	<b>COD M – AD – 07 - 01 - 03</b>	<b>APROBARE Hotărâre de Senat 40/28.02.2023</b>

Canada, Prince Edward Island	High School Graduation Diploma
Canada, Quebec	Diplôme d'Etudes Collégiales/ Diploma of Collegial Studies
Canada, Saskatchewan	Complete Grade 12 Standing/ Division IV Standing (Record of High School Standing)
Canada, Yukon	Yukon Secondary School Graduation Diploma
Republic of Cabo Verde	Ensino Secundario – 2 ° ciclo/ Certificado de Habilitações Literarias
Caribbean (Anguilla/ Antigua and Barbuda/ Barbados/ Belize/ Virgin Islands / Cayman Islands/ Dominica/ Granada/ Guyana/ Jamaica/ Montserrat/ St Kitts & St Nevis/ St Lucia/ St Vicent & Grenadines/ Trinidad & Tobago/ Turks & Insulele Caicos)	Caribbean Secondary Education Certificate (CSEC) + Caribbean Advanced Proficiency Certificate (CAPE)
Czech Republic	Vysvědčení o maturitní zkoušce obținută la un Gimnaziu/ Vysvědčení o maturitní zkoušce (educație generală) de la Stredni odborna skola/ Maturitní zkouška
Chile	Licencia de Educacion media/ Licencia de Enseñanza Media Humanística/ Científica/ Técnico-Profesional or Artistica
China	Senior Secondary School Examination
Ciud	Baccalauréat/ Diplôme de Bachelier de l'Enseignement de Second Degré + Relevé des notes
Cyprus	Lise Diploması/ Apolytirion
Colombia	Diploma de Bachiller Academico/ Comercial/ Técnico + certificado notas
Comore	Baccalauréat de l'Enseignement du Second Degré + Relevé des notes
Congo (Brazzaville)	Baccalauréat de l'Enseignement du Second Degré (Enseignement Général)+Relevé des notes
Congo (Zair)	Diplôme d'Etat d'Etudes secondaires du Cycle long/ Baccalauréat + Relevé des notes
Ivory Coast	Diplôme de Bachelier de l'Enseignement du Second Degré/ Baccalaureat de l'Enseignement Secondaire + Releve des notes
South Korea	Ilbankye Kodung Hakkyo (General High School Diploma)/ Certificate of Graduation + Transcript
North Korea	Graduation Certificate of Senior Middle School
Costa Rica	Bachillerato/ Diploma Conclusión de Estudios de Educación Diversificada/ Bachiller Educación Media + certificado notas
Croatia	Svjedodžba o završnom ispitu/ Svjedodžba (državnoj) o maturi/ Maturatna svjedodžba/ Svjedodžba o završenom srednjem obrazovanju
Cuba	Diploma de Bachiller en Ciencias y Letras/ Título de Bachiller (nivel medio superior de la Education General) - Certificado de Estudios Secundarias/ Terminados

<b>Universitatea Națională de Educație Fizică și Sport din București</b>  <b>Admitere</b>	<b>ADMISSION TO 1<sup>ST</sup> CYCLE BACHELOR'S PROGRAMMES STUDY PROGRAMME IN FOREIGN LANGUAGE</b>	<b>EDIȚIA: 1 REVIZIA: 3</b>
	<b>COD M – AD – 07 - 01 - 03</b>	<b>APROBARE Hotărâre de Senat 40/28.02.2023</b>

Denmark	Højere Handelseksamen (HHX)/ Højere Teknisk Eksamen (HTX)/ Bevis for Højere Forberedelseksamen (HF)/ Studentereksamensbevis (STX)
Djibouti	Baccalauréat de l'Enseignement Secondaire + Relevé des notes
Dominican Republic	Diploma de Bachiller/ Diploma de Conclusion de la Educacion Media/ Certificacion (Pruebas Nacionales de Conclusion de la Educación Media)
Ecuador	Título de Bachiller Unico Integral/ Diploma Bachiller en Arte/ Ciencias/ Técnico
Egypt	Thanaweya Am'ma (General Secondary Education Certificate)
Greece	Apolytirion (Secondary School Leaving Certificate)
El Salvador	Diploma Bachiller General
Switzerland	Certificat de Maturité/ Maturity Certificate/ Maturitätszeugnis/ Maturitatsausweis / Baccalauréat
United Arab Emirates	General Secondary Education Certificate (Shahadat Al-Tawjihiya)
Eritrea	Eritrean Secondary Education Certificate Examination (ESECE)
Estonia	Gümnaasiumi lõputunnistus + Riigieksamitunnistus
Eswatini (ex- Swaziland)	Cambridge Overseas School Certificate (COSC) A level
Ethiopia	Ethiopian General Secondary Education Certificate (junior secondary education) + Ethiopian Higher Education Entrance Examination Certificate
Feroe Islands	Gymnasialt miðnámsprógv/ Studentereksamen/ Højere handelseksamen (HHX)/ Højere teknisk eksamen (HTX)/ Højere forberedelseksamen (HF)/ Højere eksamen inden for fiskeri (HTX)
Fiji	Fiji School Leaving Certificate Examination/ New Zealand School Certificate/ Fiji Seventh Form Examination Certificate
Philippines	High School Diploma
Finland	Ylioppilastutkintotodistus (Studentsexamensbetyg)
France	Diplôme de baccalauréat général, Diplôme de baccalauréat technologique/ Diplôme de Baccalauréat Professionnel/ Diplôme de Baccalauréat de l'Enseignement du Second Degré.
Gabon	Baccalauréat + Relevé de notes
Gambia	West African Examinations Council Senior Secondary School Leaving Certificate/ West African Senior School Certificate Examination (WASSCE)
Georgia	Sashualo Skolis Atestati/ Secondary School Leaving Certificate + transcript with all subjects and grades
Germany	Zeugnis der Allgemeinen Hochschulreife (Abitur)
Ghana	West African Senior Secondary School Certificate (WASSSCE)
Guadalupe	Baccalauréat Deuxième Partie
Guatemala	Diploma de Bachiller en Ciencias y Letras
Guinee (Conakry)	Baccalauréat Unique/ Baccalauréat 2eme Partie + Relevé de notes
Guinee Bissau	Certificado de Conclusao do Ensino Secundario
Haiti	Certificat de Fin d'Etudes Secondaires Classiques (Première + Deuxième Partie)/ Diplôme d'Etudes Secondaires (Première + Deuxième Partie) (système traditionnel)/ Baccalauréat/ Diplôme

<b>Universitatea Națională de Educație Fizică și Sport din București</b>  <b>Admitere</b>	<b>ADMISSIONTO1<sup>ST</sup>CYCLE BACHELOR'S PROGRAMMES</b> <b>STUDY PROGRAMME IN FOREIGN LANGUAGE</b>	<b>EDIȚIA: 1</b> <b>REVIZIA: 3</b>
	<b>COD M – AD – 07 - 01 - 03</b>	<b>APROBARE</b> <b>Hotărâre de Senat</b> <b>40/28.02.2023</b>

Honduras	d'Enseignement Secondaire (système réformé)
Hong Kong	Bachillerato/ Titulo de Bachiller en Ciencias y Letras Hong Kong Diploma of Secondary Education/ Hong Kong Certificate of Education Examination (HKCEE) + Hong Kong Advanced Level Examination (HKALE)/ Hong Kong Advanced Supplementary Level Examination
India	All India Senior School Certificate (AISSC) de la Central Board of Secondary Education (CBSE)/ Indian School Certificate (ISC) de la Council for the Indian School Certificate (CISCE)/ Higher Secondary Certificate (HSC)/ Intermediate Certificate/ Pre-University Certificate, + Statement of Marks
Indonesia	Surat Tanda Tamat Belajar Sekolah Menengah Unum/ IJAZAH Sekolah Menengah Atas (SMA)/ Madrasah Aliyah (MA)/ Certificate of Completion of Upper Secondary School
Jordan	Tawjihi/ General Secondary Education Certificate/Vocational Secondary Education Certificate (exclusiv, pentru domeniul tehnic)
Iraq	Secondary School Certificate (Baccalauréat examination)/ Certificate (Baccalauréat examination)/ Preparatory Baccalauréat/ Sixth Form Baccalauréat (Adadiyah) -
Iran	Diplom-e-Motavasete (High School Diploma) + Peeshdanesghahe (Pre-University year) pentru promoțiile anterioare anului 2020
Ireland	Leaving Certificate (Ardteistmeireacht)
Iceland	Stúdentspróf (Matriculation Examination)
Israel	Israïl Te'udat Bagrut/ Matriculation Certificate + Psychometric Entrance Test (PET)
Italy	Diploma di superamento dell'esame di stato conclusivo dei corsi di studio di istruzione secondaria superiore/ Diploma di Maturita
Japan	Kotogakko Sotsugyo Shomeisho (High School Certificate of Graduation)
Kazakhstan	Attestat (Certificate of Secondary Education)
Kenya	Kenya Certificate of Secondary Education (KCSE)
Kosovo	Diploma de finalizare a studiilor liceale (Matura/ Diploma për kryerjen e shkollës së mesme te pergjithsme – gjimnazin) + Testi i Maturës Shtetërore
Kuwait	Shahadat Al-Thanawiya-Al-A'ama (General Secondary School Certificate)
Kyrgyzstan	Attestat (Certificate of Secondary Education)
Laos	Baccalauréat de l'Enseignement General + Releve des notes
Lesotho	Cambridge Overseas School Certificate
Latvia	Atestāts par visparejo videjo izglitību (Certificate of Secondary Education)
Lebanon	Baccalauréat général (Libanais)/ Baccalauréat Technique, pentru continuarea studiilor în același domeniu
Liberia	Senior School Certificate (SSC)/ Senior High School Certificate (SHSC) eliberate de West African Examination Council
Libya	General Secondary Certificate
Liechtenstein	Maturazeugnis des Lichtensteinischen Gymnasiums

<b>Universitatea Națională de Educație Fizică și Sport din București</b>  <b>Admitere</b>	<b>ADMISSIONTO1<sup>ST</sup>CYCLE BACHELOR'S PROGRAMMES STUDY PROGRAMME IN FOREIGN LANGUAGE</b>	<b>EDIȚIA: 1 REVIZIA: 3</b>
	<b>COD M – AD – 07 - 01 - 03</b>	<b>APROBARE Hotărâre de Senat 40/28.02.2023</b>

Lithuania	Brandos atestatas (Maturita-certificate)
Luxemburg	Diplôme/ Certificat de Fin d'Etudes secondaires/ Diplôme de Fin d'Etudes Secondaires Techniques
Northern Macedonia	Svidetelstvo za zavreno sredno obrazovanie (Secondary School Leaving Certificate)
Madagascar	Baccalauréat de l'Enseignement secondaire + Relevé des notes
Malawi	Malawi School Certificate of Education
Malaysia	Sijil Pelajaran Malaysia + Sijil Tinggi Persekolahan Malaysia/ Matriculation Certificate
Mali	Baccalaureat Malien – 2eme Partie + Relevé des notes
Malta	Matriculation Certificate
Morocco	Attestation/ Diplome du Baccalauréat + Relevé des notes
Mauritania	Baccalauréat de l'Enseignement du Second Degré + Relevé des notes
Mauritius	School Certificate/ General Certificate of Education Ordinary Level + Higher School Certificate/ General Certificate of Education Advanced Level
Mexico	Diploma de Bachiller General
Republic of Moldova	Diploma de bacalaureat cu Tabelul de note generale
Monaco	Baccalauréat de l'Enseignement Général + Releve des notes
Mongolia	Gerchilgee Certificate of Secondary Education
Mozambique	Certificado de Habilitações Literarias
Montenegro	Diploma o Završenoj Srednjoj Školi/ Diploma o položzenom zavrshnom ispitu (Secondary School Leaving Certificate)
Namibia	Namibia Senior Secondary Certificate (Higher and Ordinary level)/ Higher International Secondary Certificate of Education (Higher and Ordinary level)
Nepal	School Leaving Certificate + Higher Secondary Certificate
New Zealand	National Certificate of Educational Achievement Level 3/ University Entrance, Bursaries and Scholarships Examination/ Sixth Form Certificate
Nicaragua	Bachillerato en Ciencias y Letras+Certificado notas
Niger	Diplôme de Bachelier de l'Enseignement du Second Degré/ Baccalauréat + Releve des notes
Nigeria	Senior School Certificate/ West African Senior School Certificate/ NECO Senior School Certificate + codul PIN, prin prezentarea copiilor față verso ale NECO Results Card/ WAEC Scratch Card
Norway	Vitnemål videregående opplæring (generell studiekompetanse) Eksamenskarakter
Netherlands	Diploma Voorbereidend wetenschappelijk onderwijs
Oman	Thanawiya Amma (General Certificate/ General Education Diploma)
Pakistan	Intermediate/ Higher Secondary School Certificate (recunoscute de Inter Board Committee of Chairmen)
Palestine	Al-Tawjihi/ Al-Injaz (General Secondary Education Certificate) eliberat conform curriculum-ului egiptean sau iordanian
Panama	Diploma Bachiller + certificado notas
Papua New Guinee	Higher School Certificate
Paraguay	Diploma Bachiller + certificado notas



<b>Universitatea Națională de Educație Fizică și Sport din București</b>  <b>Admitere</b>	<b>ADMISSION TO 1<sup>ST</sup> CYCLE BACHELOR'S PROGRAMMES STUDY PROGRAMME IN FOREIGN LANGUAGE</b>	<b>EDIȚIA: 1 REVIZIA: 3</b>
	<b>COD M – AD – 07 - 01 - 03</b>	<b>APROBARE Hotărâre de Senat 40/28.02.2023</b>

Peru	Certificado Oficial de Estudios/ Educación básica regular nivel de education secundaria + certificado notas
Poland	Świadectwo dojrzałości Liceum Ogólnokształcącego
Portugal	Diploma de estudos/ ensino secundários/ Certidão de habilitações
Puerto Rico	High School Diploma + transcript of studies
Qatar	Al-Thanaawiya Aama Qatari (Qatar General Secondary Education Certificate)
Russia	Attestat
Great Britain and Northern Ireland	General Certificate of Secondary Education + General Certificate of Education
Wales	Welsh Baccalaureat/ Advanced diploma
Scotland	Scottish Certificate of Secondary Education/Scottish Qualifications Certificate
Rwanda	Rwanda Advanced Certificate of Education/ Diplôme de Fin d'Etudes secondaires/ Certificat du Cycle Supérieur de l'Enseignement Secondaire/ Diplôme d'Humanités Générales/ Advanced General Certificate of Secondary Education (eliberat de Rwanda Education Board) + Relevé des notes
Samoa	Pacific Senior Secondary Certificate/ Western Samoa School Certificate
San Marino	Diploma di maturità
Senegal	Diplôme de Baccalauréat/ Diplôme de Baccalauréat de l'Enseignement Secondaire/ Diplôme de Bachelier de l'Enseignement de Second Degré + Relevé des notes
Serbia	Diploma/ Uverenje o položenom maturalnom ispitu/ Diploma o stečenom srednem obrazovanju/ Diploma o Završenoj Srednjoj Školi
Seychelles	General Certificate of Secondary Education/ Cambridge Overseas Higher School Certificate
Sierra Leone	West African Senior School Certificate Examination/ General Certificate of Education (GCE)
Singapore	Cambridge General Certificate of Education Ordinary + Cambridge General Certificate of Education Advanced Level
Syria	Al Shahâda Al Thânaawiyya al-Imma (General Secondary Education Certificate)/ Baccalaureat
Slovakia	Vysvedčenie o maturitnej skuske (Gymnázium)
Slovenia	Spričevalo o splosni maturi (Splosna Matura)
Solomon Island	Pacific Senior Secondary Certificate/ Solomon Island School Certificate
Somalia	Shahaadada Dugsiga Dare (Secondary School Leaving Certificate)/ Somaliland Certificate of Secondary Education Examination (issued by Somaliland National Examination and Certification Board, SLNECB)
Spain	Titulo de Bachiller (Baccalaureate) + Pruebas de Aptitud para el Acceso a la Universidad, calificación Apto
Sri Lanka	Sri Lanka General Certificate of Education Ordinary Level + Sri Lanka General Certificate of Education Advanced Level (A level)
USA	High School Diploma/ General Educational Development (GED)/ High School Equivalency Diploma + Scholastic Aptitude Test (SAT)/

<b>Universitatea Națională de Educație Fizică și Sport din București</b>  <b>Admitere</b>	<b>ADMISSION TO 1<sup>ST</sup> CYCLE BACHELOR'S PROGRAMMES STUDY PROGRAMME IN FOREIGN LANGUAGE</b>	<b>EDIȚIA: 1 REVIZIA: 3</b>
	<b>COD M – AD – 07 - 01 - 03</b>	<b>APROBARE Hotărâre de Senat 40/28.02.2023</b>

Sudan	Advanced Placement Test (APT)/ American College Testing (ACT) Sudanese School Certificate/ Sudanese Secondary School Certificate/ Higher Secondary School Certificate
Sweden	Examensbevis Högskoleförberedande examen/ Slutbetyg Fran Gymnasieskola
Surinam	Voorbereidend Wetenschappelijk Onderwijs
International schools	High school diplomas issued by private educational institutions that carry out educational activities corresponding to an educational system from a country other than the one in which the respective institution operates and are issued in accordance with the adopted educational system. A cumulative condition for international schools operating in Romania is registration in the ARACIP Register..
Taiwan	Senior High School Leaving Certificate
Tajikistan	Attestat (Certificate of Secondary Education)
Thailand	Certificate of Secondary Education/Certificate of Completion grade 12/ Matayom VI/ Maw 6
Tanzania	Certificate of Secondary Education and Advanced Certificate of Secondary Education (ACSE)/ National Form VI Examination Certificate/ General Certificate of Secondary Education (O level) + National Form VI Examination Certificate/ Advanced Certificate of Secondary Education
Eastern Timor	Diplomas do Ensino Secundário
Togo	Diplome de Bachelier de l'Enseignement du Troisième Degré/ Baccalauréat de l'Enseignement du Troisième Degré + Releve des notes
Tonga	Tonga National Form Seven Certificate + Pacific Senior Certificate
Tunisia	Baccalauréat/ Diplôme de Bachilier de l'Enseignement secondaire + Relevé des notes
Turkey	Lise Diplomasi – acces general/ Teknik Lisesi Diplomasi – acces exclusiv la domeniile tehnice/ Associate degree – acces exclusiv în același domeniu
Turkmenistan	Attestat/ Orta bilim hakynda Sahadatnama (Certificate of Secondary Education)
Ukraine	Attestat (Certificate of Secondary Education)
Uganda	Uganda Certificate of Education (UCE) + Uganda Advanced Certificate of Education
Hungary	Gimnazium Érettségi Bizonyítvány
Uruguay	Bachillerato Oficial/ Bachillerato Tecnico + Certificado de estudios
Uzbekistan	Attestat o srednem obrazovanii/ Orta malumot togrisida shahodatnoma
Vanuatu	Pacific Senior Secondary Certificate
Vatican	Testimonio Maturitatis
Venezuela	Título de Educación Media General/ Título de Educación Media Técnica/ Titulo de Bachiller + Certificado notas
Vietnam	Bang Tót Nghiep Phó Thông (Certificate of Secondary School Graduation)/ Bang Tu Tai Hai (Baccalauréat II
Yemen	Al Thanawiya (General Secondary Education Certificate)
Zambia	Zambian School Certificate/ Cambridge Overseas School Certificate

<b>Universitatea Națională de Educație Fizică și Sport din București</b>  <b>Admitere</b>	<b>ADMISSION TO 1<sup>ST</sup> CYCLE BACHELOR'S PROGRAMMES STUDY PROGRAMME IN FOREIGN LANGUAGE</b>	<b>EDIȚIA: 1 REVIZIA: 3</b>
	<b>COD M – AD – 07 - 01 - 03</b>	<b>APROBARE Hotărâre de Senat 40/28.02.2023</b>

Zimbabwe

General Certificate of Education (GCE) Ordinary level + Zimbabwe  
General Certificate of Education at Advanced Level/ Zimbabwe  
General Certificate of Education at Ordinary Level/ General Certificate  
of Education (GCE)

*Appendix C*

Universitatea Națională de Educație Fizică și Sport din București  Admitere	ADMISSIONTO1 <sup>ST</sup> CYCLE BACHELOR'S PROGRAMMES STUDY PROGRAMME IN FOREIGN LANGUAGE	EDIȚIA: 1 REVIZIA: 3
	COD M – AD – 07 - 01 - 03	APROBARE Hotărâre de Senat 40/28.02.2023

## DECLARAȚIE PRIVIND ACORDAREA CONSIMȚĂMÂNTULUI ÎN VEDEREA PRELUCRĂRII DATELOR CU CARACTER PERSONAL

Subsemnatul/a (nume, prenume) \_\_\_\_\_, domiciliat/ă în localitatea \_\_\_\_\_, județul \_\_\_\_\_, strada \_\_\_\_\_, posesor al CI seria \_\_\_\_\_ numărul \_\_\_\_\_, eliberat de \_\_\_\_\_, la data de \_\_\_\_\_,

**Îmi exprim consimțământul ca Universitatea Națională de Educație Fizică și Sport din București – Facultatea de Educație Fizică și Sport / Facultatea de Kinetoterapie, cu sediul în București, Str. Constantin Noica, Nr. 140, Sector 6, C.P.060057, să prelucreze următoarele date cu caracter personal:**

1. Nume și prenume;
2. Prenumele părinților;
3. Data și locul nașterii (țara, județul/localitatea, localitatea/sectorul);
4. CNP;
5. Sexul;
6. Domiciliul stabil, reședința, codul poștal;
7. Naționalitatea și cetățenia;
8. Etnia;
9. Stare socială specială;
10. Situație medicală specială;
11. Fotografie recentă;
12. Date de contact (număr telefon, e-mail) ;
13. Date carte de identitate/pașaport (serie, număr, emitent, valabilitate) ;
14. Studii preuniversitare: date de identificare adeverință/diplomă bacalaureat (emitent, serie și număr act de studiu, filieră, profil, specializare, promoție, medie) ;
15. Studii universitare de licență/masterat/doctorat: date de identificare adeverință/diplomă, serie și număr act de studiu, domeniul, programul de studiu, promoția, media, titlul și coordonatorul lucrării;
16. Date pentru: repartiție buget-taxă.

Declar că sunt de acord ca prelucrarea datelor cu caracter personal furnizate de către subsemnatul/subsemnata să se realizeze în perioada **15 iunie – 1 decembrie 2023**, în următoarele scopuri: **EXAMEN DE ADMITERE**.

Înțeleg și sunt de acord ca datele cu caracter personal să fie dezvăluite către următoarele categorii de destinatari: **Ministerul Educației Naționale, Ministerul Educației-Direcția Generală Relații Internaționale și Afaceri Europene, Ministerul Afacerilor Externe.**

Am luat cunoștință de faptul că îmi pot exercita toate drepturile prevăzute de Regulamentul UE 2016/679, astfel:

- a) Dreptul la informare: dreptul de a fi informat cu privire la identitatea operatorului, scopul în care se face prelucrarea datelor, destinatarii sau categoriile de destinatari ai datelor, perioada pentru care vor fi stocate datele sau criteriile utilizate pentru a stabili această perioadă, existența drepturilor prevăzute de Regulamentul UE 2016/679 pentru persoana vizată și condițiile în care pot fi exercitate.
- b) Dreptul de acces la date: dreptul de a obține din partea operatorului o confirmare că se prelucrează sau nu date cu caracter personal care o privesc și, în caz afirmativ, acces la datele respective și la informațiile prevăzute de lege.
- c) Dreptul de rectificare a datelor: dreptul de a obține de la operator, fără întârzieri nejustificate, rectificarea datelor cu caracter personal inexacte care o privesc.
- d) Dreptul la ștergerea datelor: dreptul de a obține din partea operatorului ștergerea datelor cu caracter personal care o privesc, fără întârzieri nejustificate, în condițiile anume prevăzute de lege.
- e) Dreptul la restricționarea prelucrării, respectiv dreptul de a obține din partea operatorului restricționarea prelucrării în cazurile anume prevăzute de lege.
- f) Dreptul la portabilitatea datelor, respectiv dreptul de a primi datele cu caracter personal care o privesc și pe care le-a furnizat operatorului într-un format structurat, utilizat în mod curent și care poate fi citit automat și dreptul de a transmite aceste date altui operator.

<b>Universitatea Națională de Educație Fizică și Sport din București</b>  <b>Admitere</b>	<b>ADMISSION TO 1<sup>ST</sup> CYCLE BACHELOR'S PROGRAMMES</b> <b>STUDY PROGRAMME IN FOREIGN LANGUAGE</b>	<b>EDIȚIA: 1</b> <b>REVIZIA: 3</b>
	<b>COD M – AD – 07 - 01 - 03</b>	<b>APROBARE</b> <b>Hotărâre de Senat</b> <b>40/28.02.2023</b>

- g) Dreptul de opoziție: dreptul de a se opune în orice moment, din motive legate de situația sa particulară, că datele care o vizează să facă obiectul unei prelucrări sau creări de profiluri, cu excepția cazurilor în care operatorul demonstrează că are motive legitime și imperioase care justifică prelucrarea și care prevalează asupra intereselor, drepturilor și libertăților persoanei vizate sau că scopul este constatarea, exercitarea sau apărarea unui drept în instanță.
- h) Dreptul de a retrage consimțământul, în orice moment, fără a afecta legalitatea prelucrării efectuate pe baza consimțământului înainte de retragerea acestuia.
- i) Dreptul de a se adresa Autorității Naționale de Supraveghere a Prelucrării Datelor cu Caracter Personal sau justiției pentru apărarea oricăror drepturi garantate de Regulamentul UE 2016/679 care le-au fost încălcate.

Toate aceste drepturi pot fi exercitate prin transmiterea unei cereri, întocmită în formă scrisă, datată și semnată, care va cuprinde solicitările formulate și motivele acestora către **UNEFS** la adresa: Bucuresti, Str. Constantin Noica, Nr. 140, Sector 6, C.P.060057, mail: **secretariat@unefs.ro**.

Declar că nu am furnizat informații false în documentele prezentate și, cunoscând dispozițiile art. 326 din Codul penal, îmi asum responsabilitatea datelor cu caracter personal furnizate, garantând că acestea sunt actuale, reale, corecte și complete.

Mă angajez ca, în eventualitatea modificărilor survenite în datele personale indicate în cadrul dosarului de înscriere (schimbare domiciliu, statut civil, etc.) să informez în scris **Comisia de Admitere** în timp util.

Am fost informat de către **UNEFS** cu privire la scopul prelucrării datelor mele cu caracter personal, al bazei legale pentru colectarea și procesarea acestora, al categoriilor de destinatari, al păstrării datelor cu caracter personal și a drepturilor pe care le am în ceea ce privește datele mele cu caracter personal.

Sunt de acord ca Universitatea Națională de Educație Fizică și Sport din București – **Facultatea de Educație Fizică și Sport / Facultatea de Kinetoterapie** să transfere în state ce nu fac parte din Uniunea Europeană datele mele cu caracter personal.

Mi s-a adus la cunoștință faptul ca refuzul meu de a furniza datele cu caracter personal necesare și solicitate de către **Comisia de Admitere** determină **neînscierea la concursul de Admitere**.

Data: \_\_\_\_\_

Semnătură,